

800X2400mm
1200X2400mm



COLLECTION 2020



Fab Slab

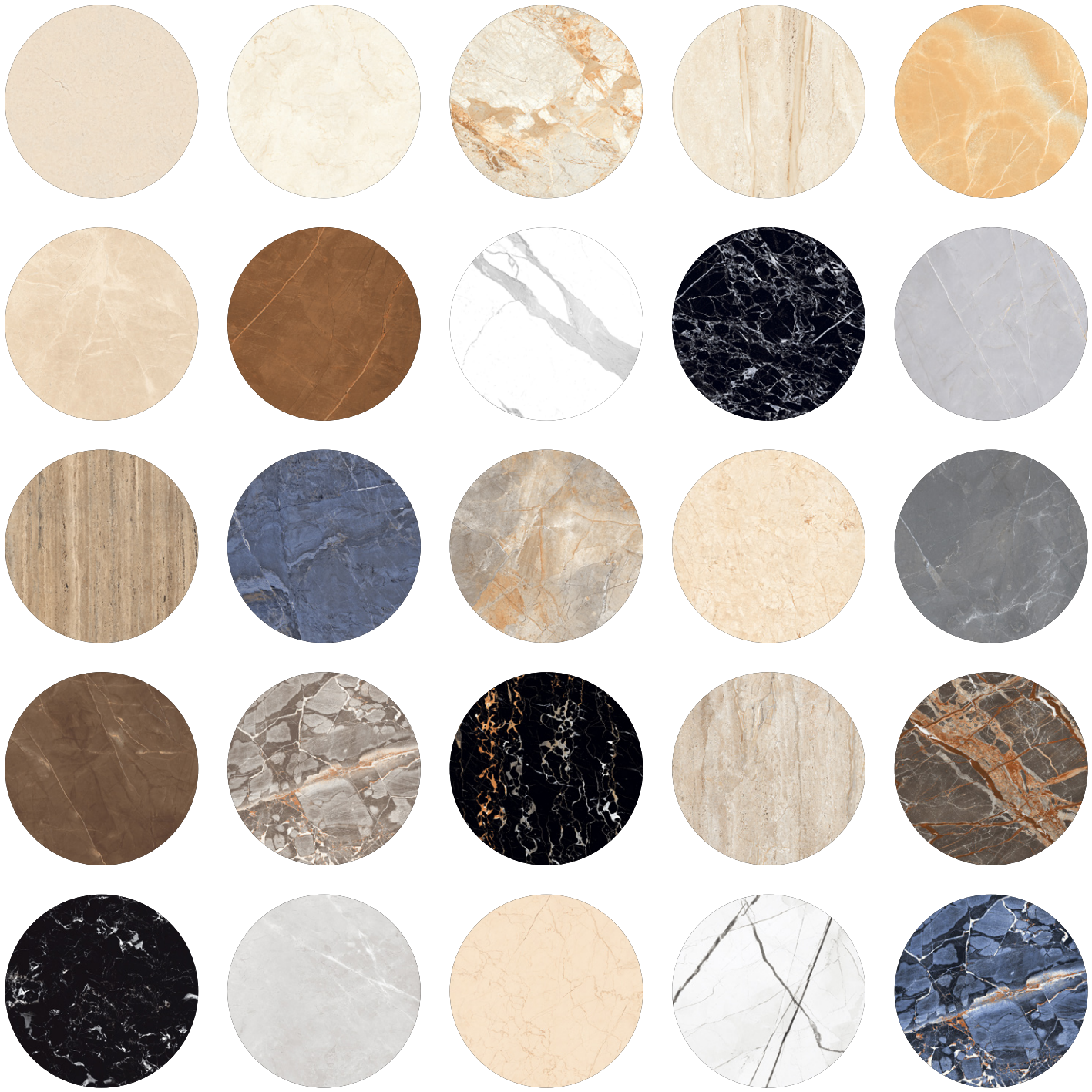

Fab Slab is a flourishing centre for Italian design and slabs. Fab Slab is a new conglomerate that offers a rich array of products and services in terms of design and manufacturing of slabs. Fab Slab represents unparalleled technical, artistic and organizational standards that distinguish it from its peers.

Fab Slab is the essence of years of rigorous research. In its core efforts, Fab Slab epitomizes the urge to establish new standards and norms in the industry. Over decades of experience has gone into the making of this ambitious venture that us set to revolutionize art and craft of manufacturing slabs. Based on ground-breaking research, Fab Slab has conceptualized its ravishing designs and world-class manufacturing process.

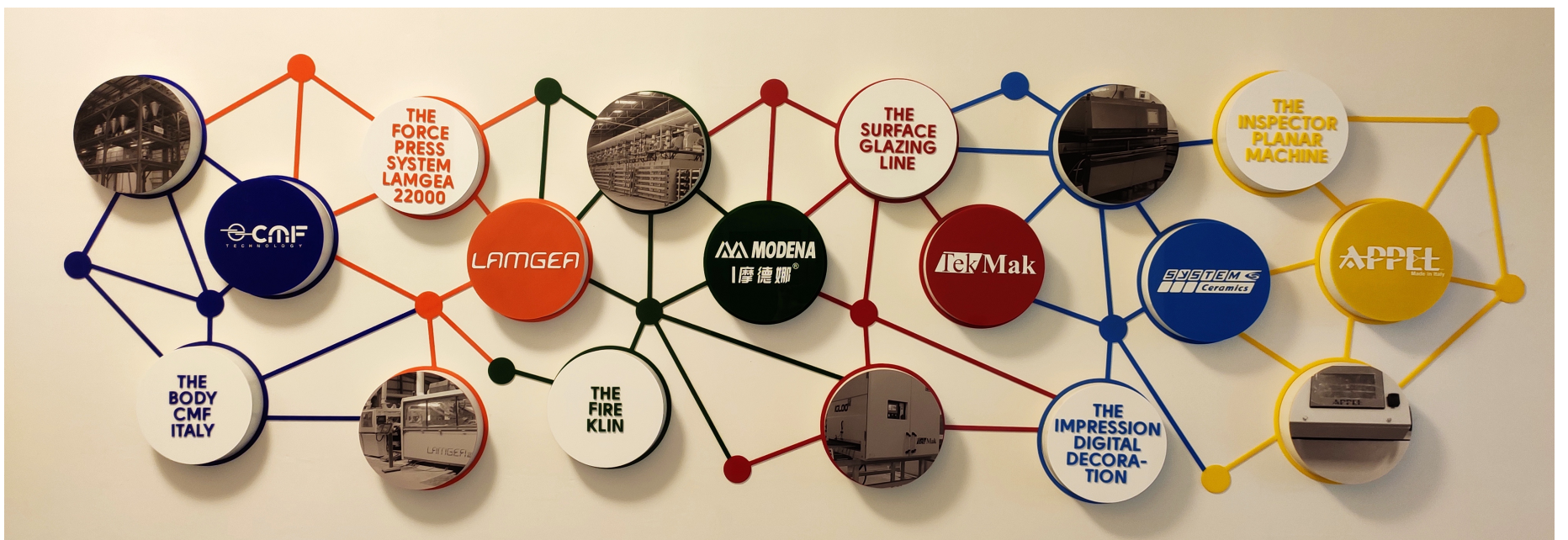



WHAT IS Fab Slab?

**STRENGTH PLUS
VERY LARGE SIZES AND
HIGH THICKNESS.**

An innovative and Italian quality porcelain slabs, ideal for kitchen countertops, bathroom countertops, furniture, flooring and wall applications. The perfect combination of quality and wide collections of texture surface like marble, stone, wood, metal & concrete.

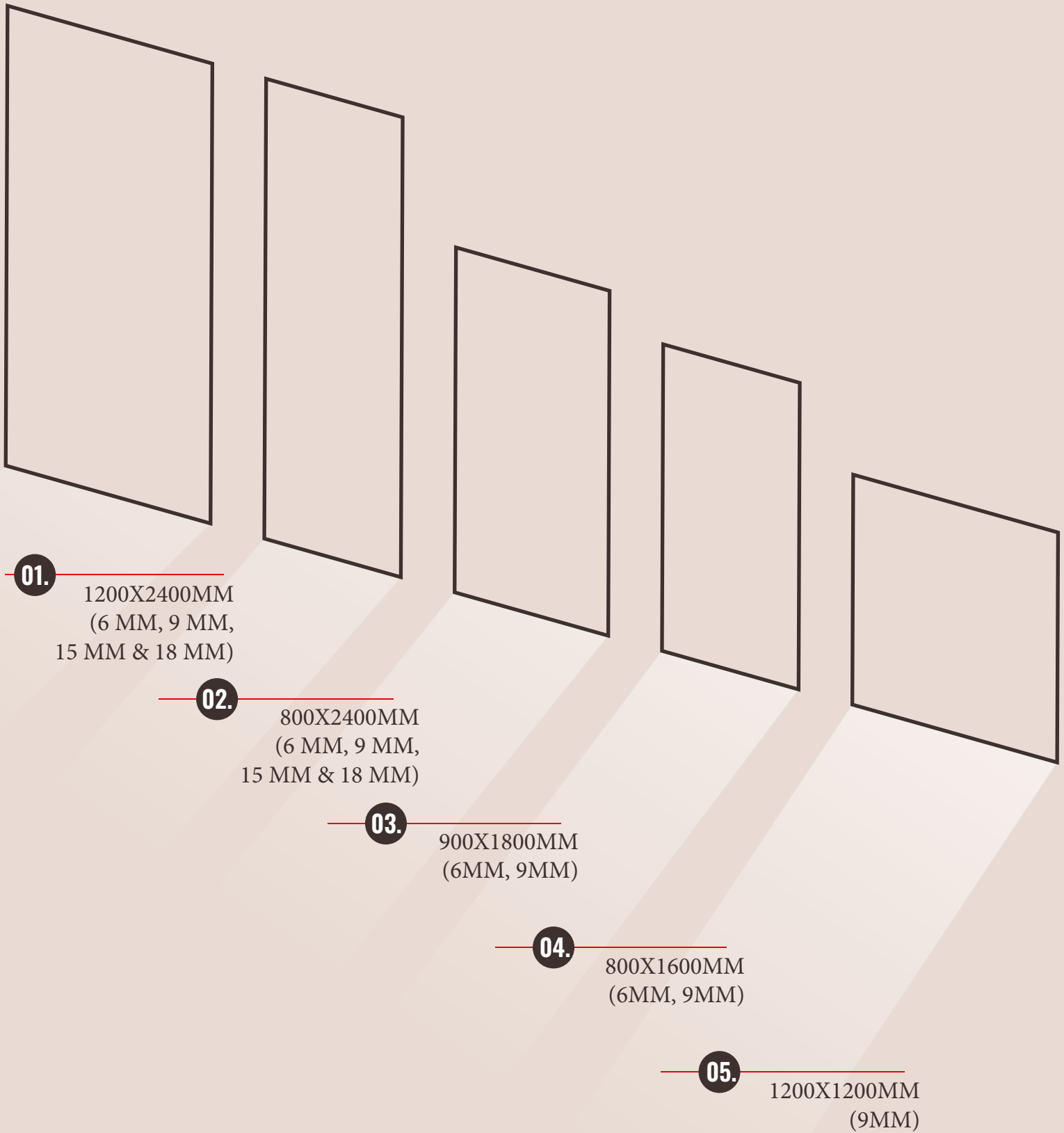

Specific answers to any need.
5 sizes, 4 thickness options

APPLICATION



AIRPORT



RESTAURANT



FITTED KITCHEN AND
BATHROOM FURNITURE



HOTELS



RETAIL MALLS



SPA AND WELLNESS
CENTRES



OFFICES



SHOPS



MUSEUMS



VENTILATED CURTAIN
WALLS



HOMES



INTERIOR DESIGN
AND FURNISHINGS

NEW PRODUCTION TECHNOLOGIES BRING UP THE CHALLENGE OF CREATING MATERIALS CAPABLE OF SHAPING THE SPACE TECHNICALLY AND ESTHETICLY IN AN EFFICIENT WAY.

Fab Slab, a brand born to provide advanced solutions to architecture and interior design. Materials that offer unlimited versatility in all fields of construction, furniture, design, etc.

FEATURES



HIGHLY UV
RESISTANT



RESISTANT TO
SCRATCHES



WATERPROOF



RESISTANCE TO
CHEMICAL ATTACK



LIGHTNESS



LIGHTNESS



FROST
RESISTANCE



RESISTANT TO
STAINS



RECYCLABLE



EASY TO CLEAN



FIREPROOF

POSSIBILITIES

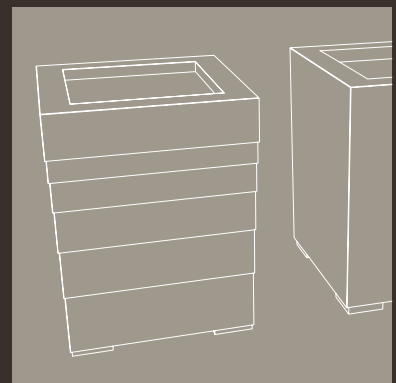
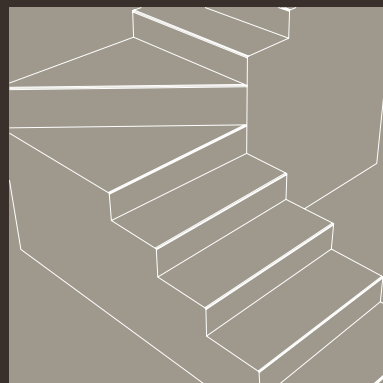
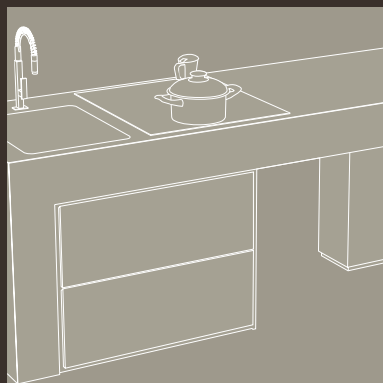
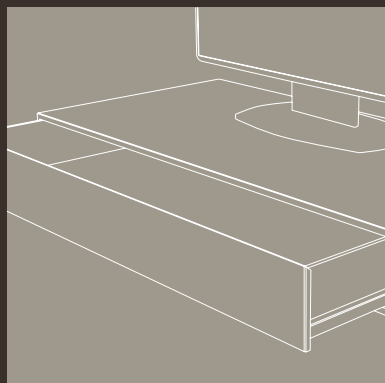
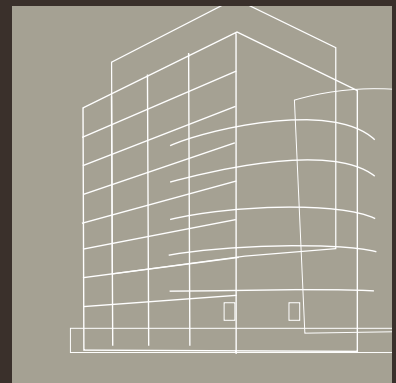
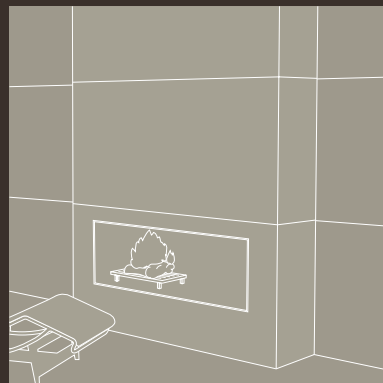
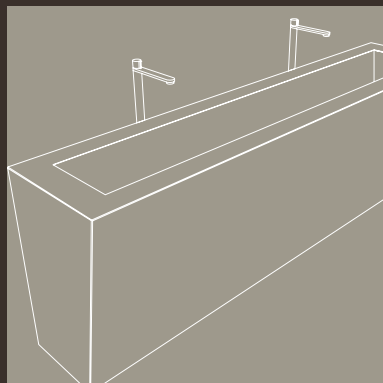
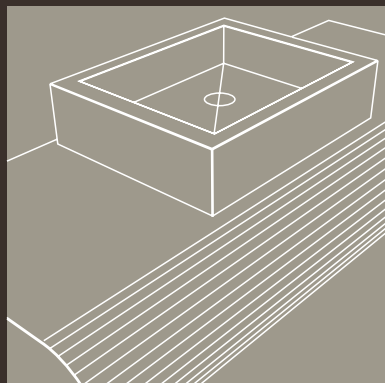
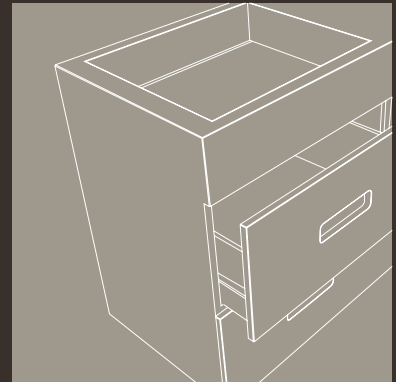
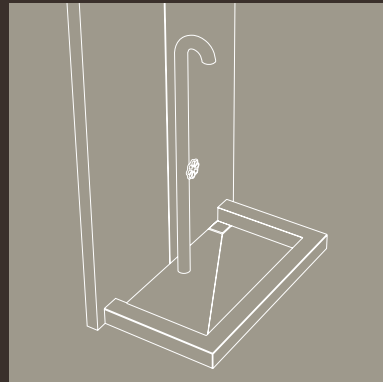
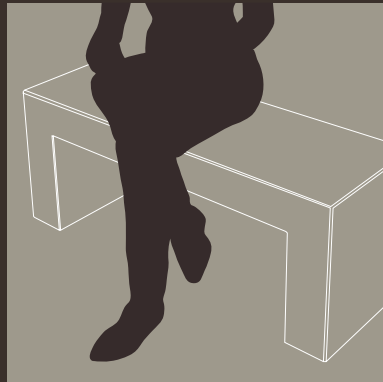
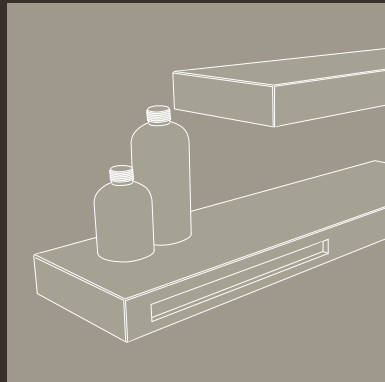

AMBRATO GOLD PLAZMA

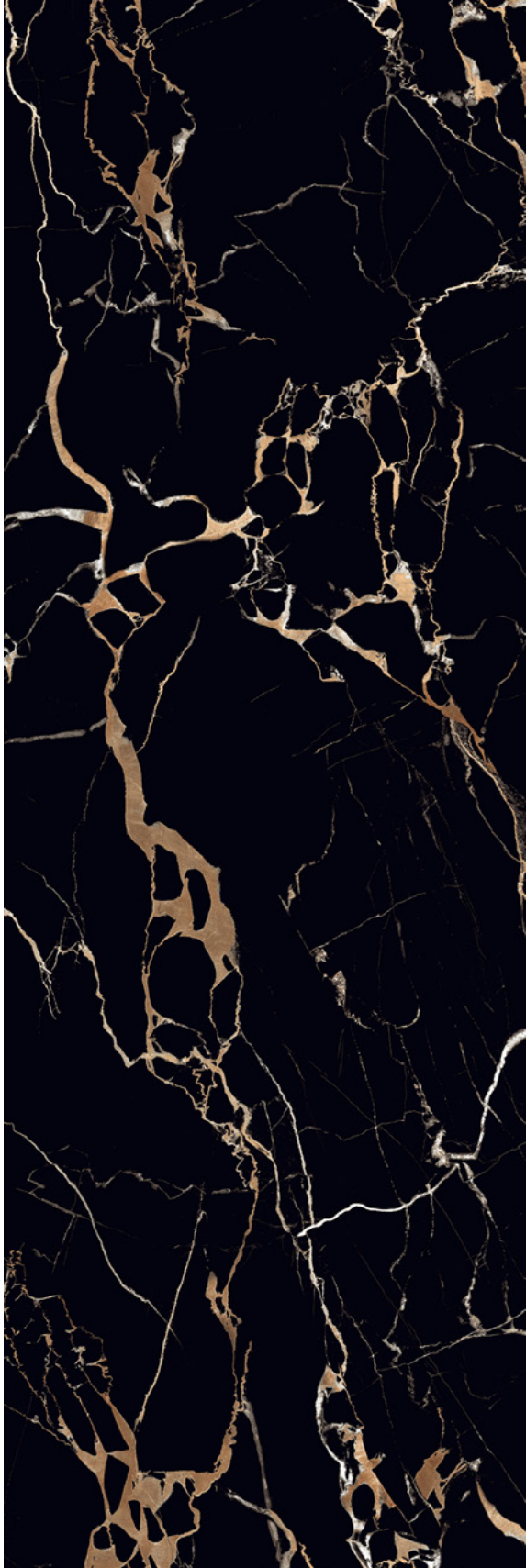

APUANE STATUARIO



THICKNESS

15MM, 18 MM

SIZE

800X2400MM

FINISH

GLOSSY

EFFECT

MARBLE

BLACK PEARL



BLUE PEARL

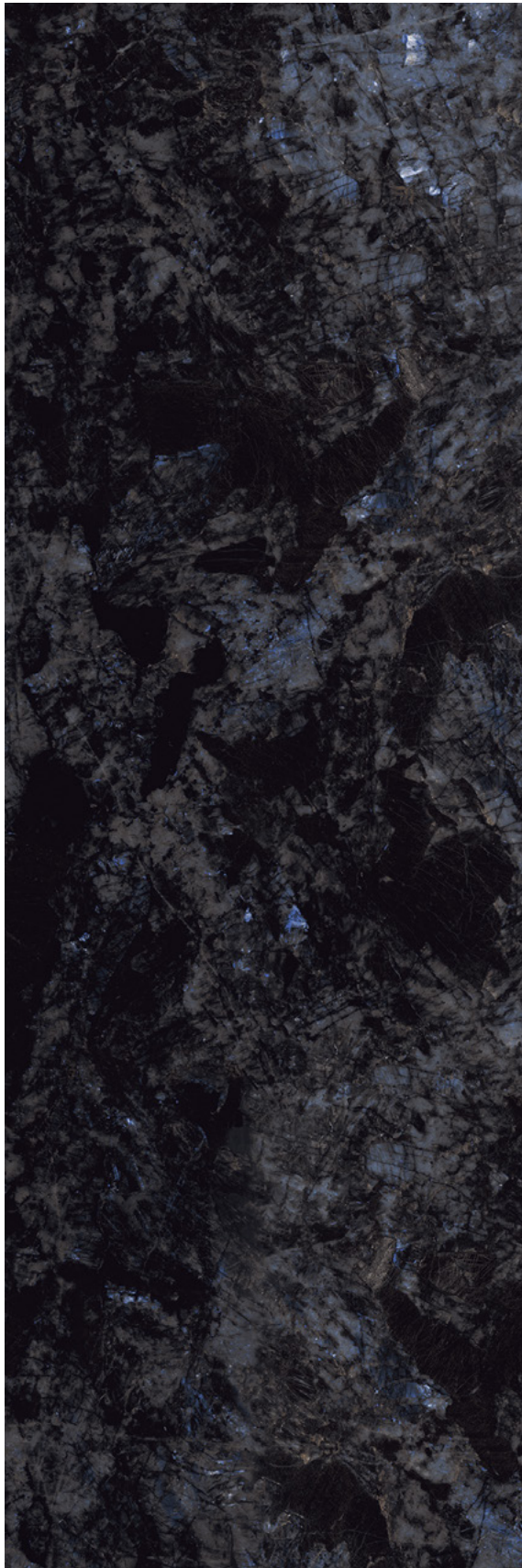

THICKNESS

15MM, 18 MM

SIZE

800X2400MM

FINISH

GLOSSY

EFFECT

MARBLE

CALCATA ELITE

CRYSTAL ONYX



THICKNESS

15MM, 18 MM

SIZE

800X2400MM

FINISH

GLOSSY

EFFECT

MARBLE

DESERT GOLD



ESSEL BROWN



THICKNESS

15MM, 18 MM

SIZE

**800X2400MM
1200X2400MM**

FINISH

GLOSSY

EFFECT

MARBLE

GLASS WHITE

JET BLACK GLAZE

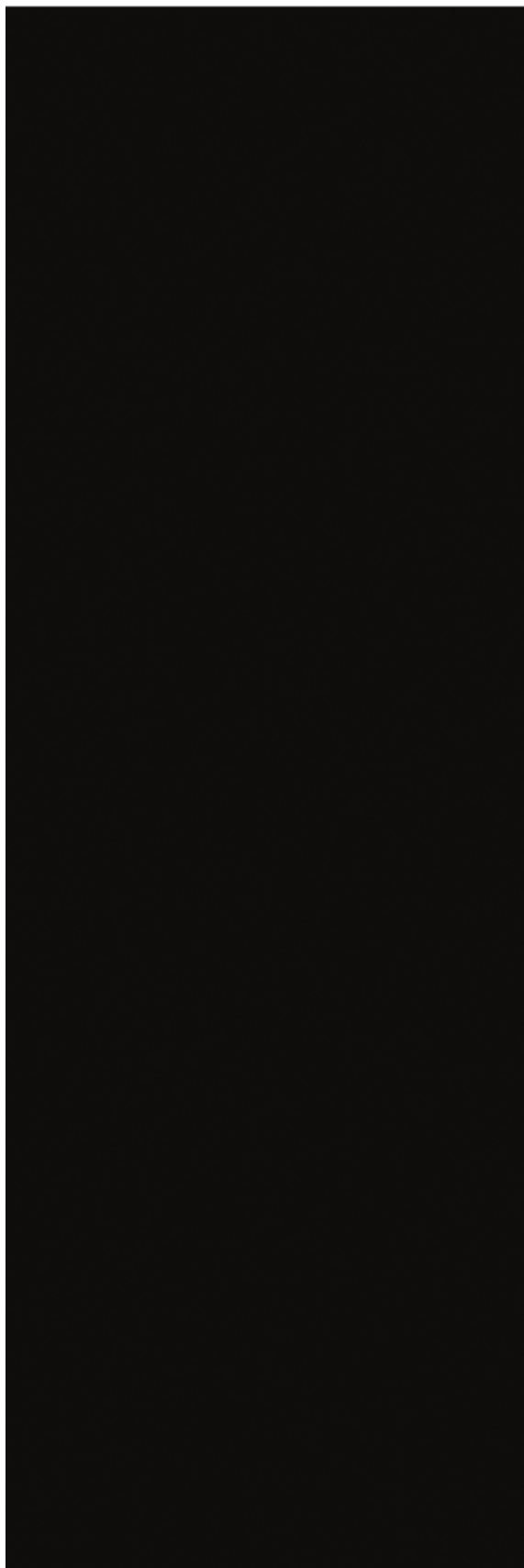
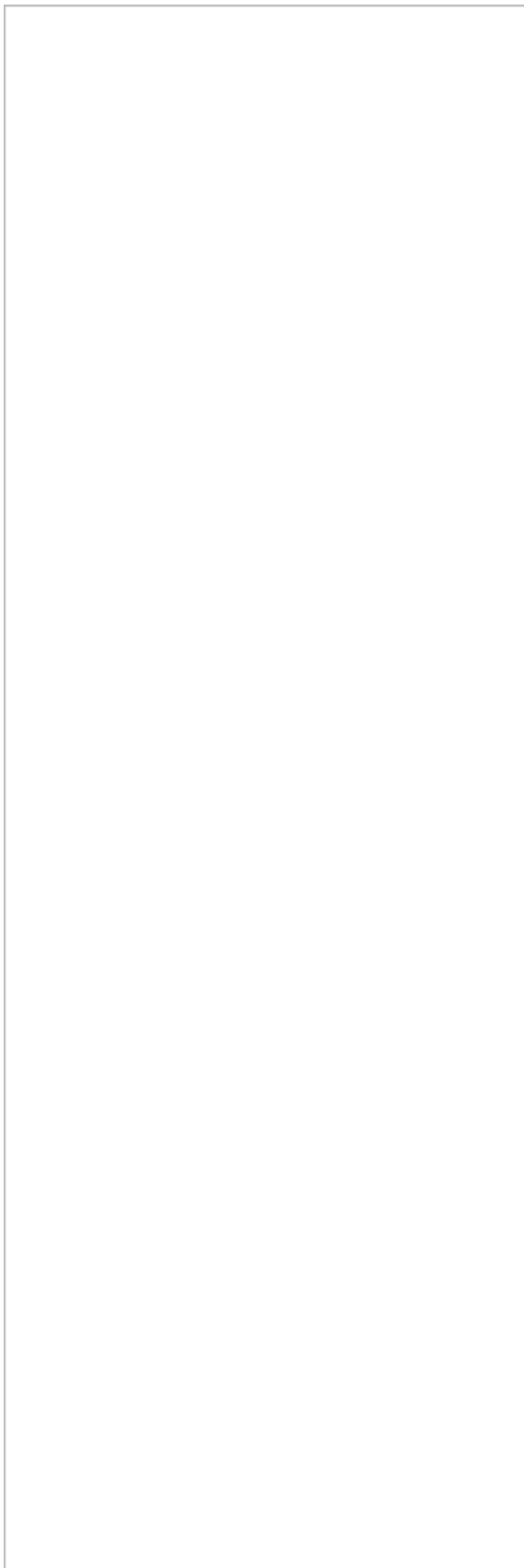

THICKNESS

15MM, 18 MM

SIZE

**800X2400MM
1200X2400MM**

FINISH

GLOSSY

EFFECT

MARBLE

IMPERIAL WHITE



GOLDEN PORTORO

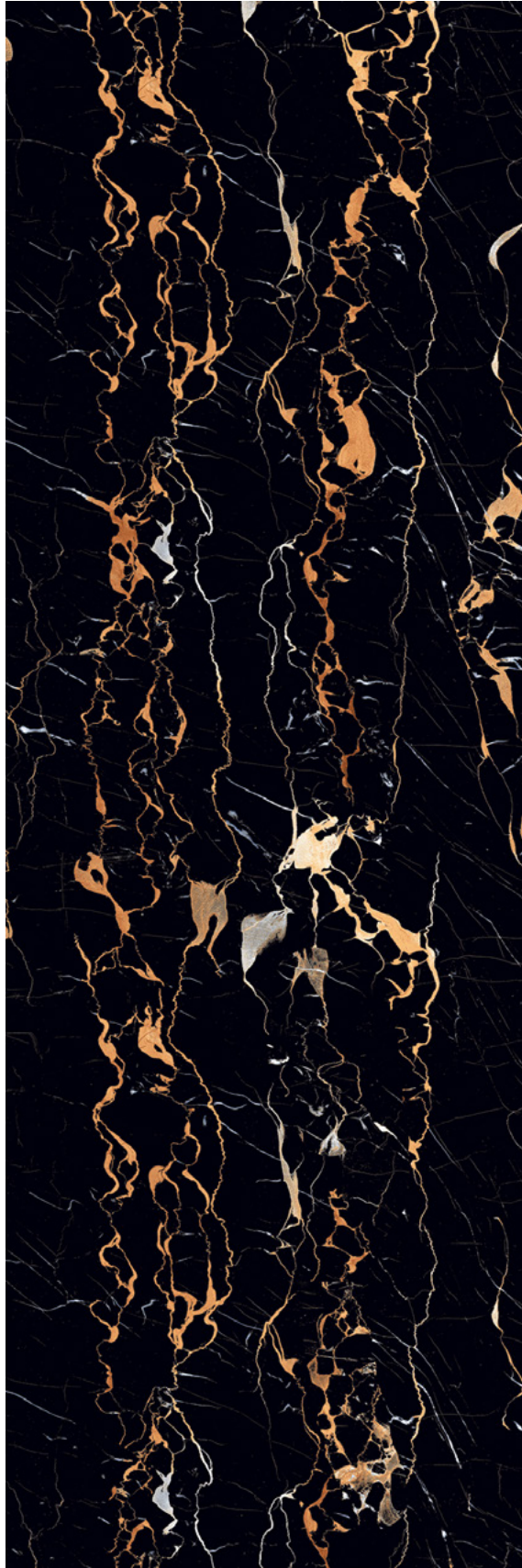

THICKNESS

15MM, 18 MM

SIZE

800X2400MM

FINISH

GLOSSY

EFFECT

MARBLE

JET BLACK

PEARL WHITE

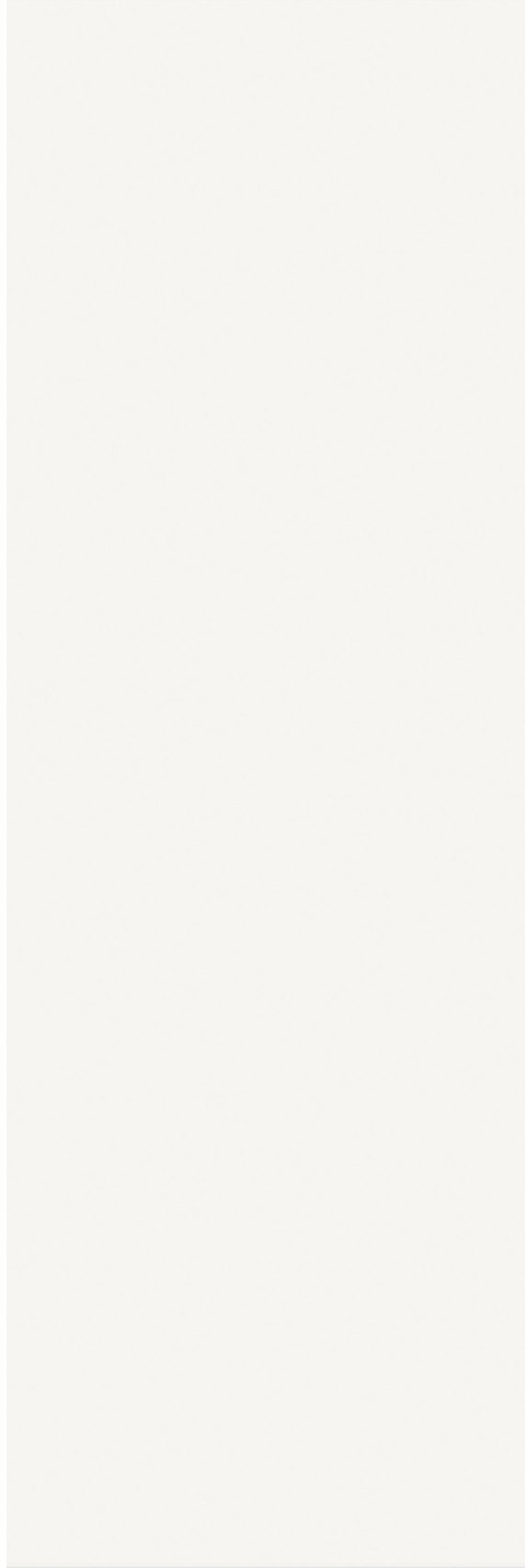

THICKNESS

15MM, 18 MM

SIZE

800X2400MM
1200X2400MM

FINISH

GLOSSY

EFFECT

MARBLE

LOURENT GOLD

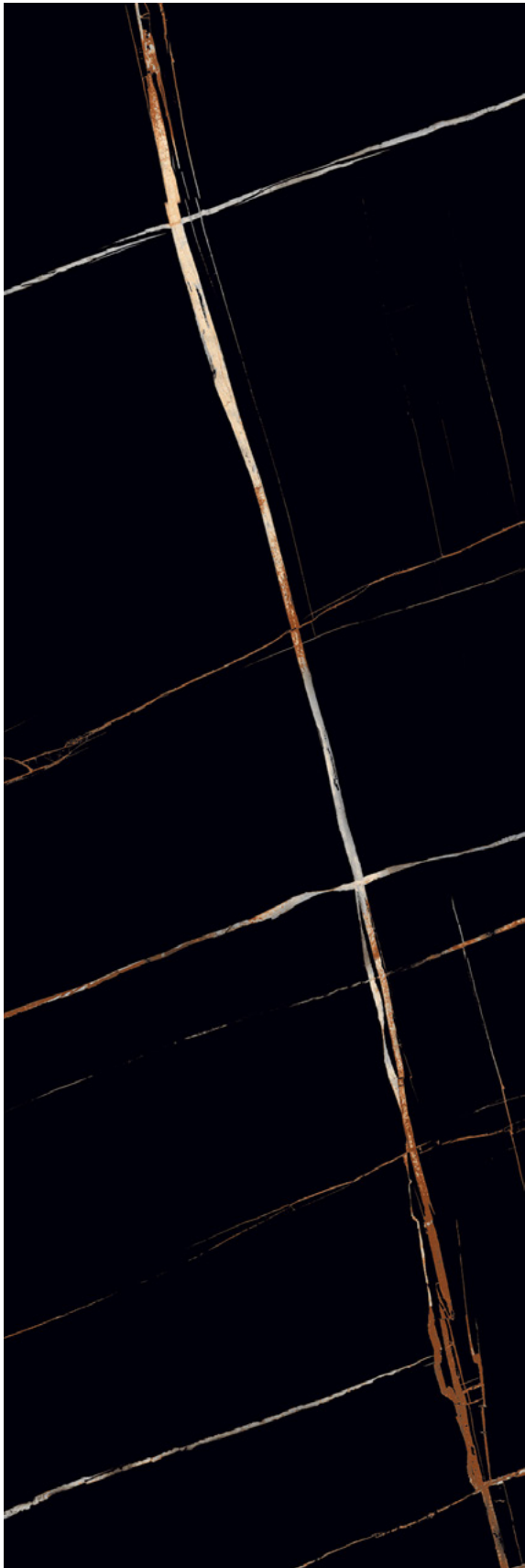

MARBLE VOLAKAS



THICKNESS

15MM, 18 MM

SIZE

800X2400MM

FINISH

GLOSSY

EFFECT

MARBLE

MARQUINA

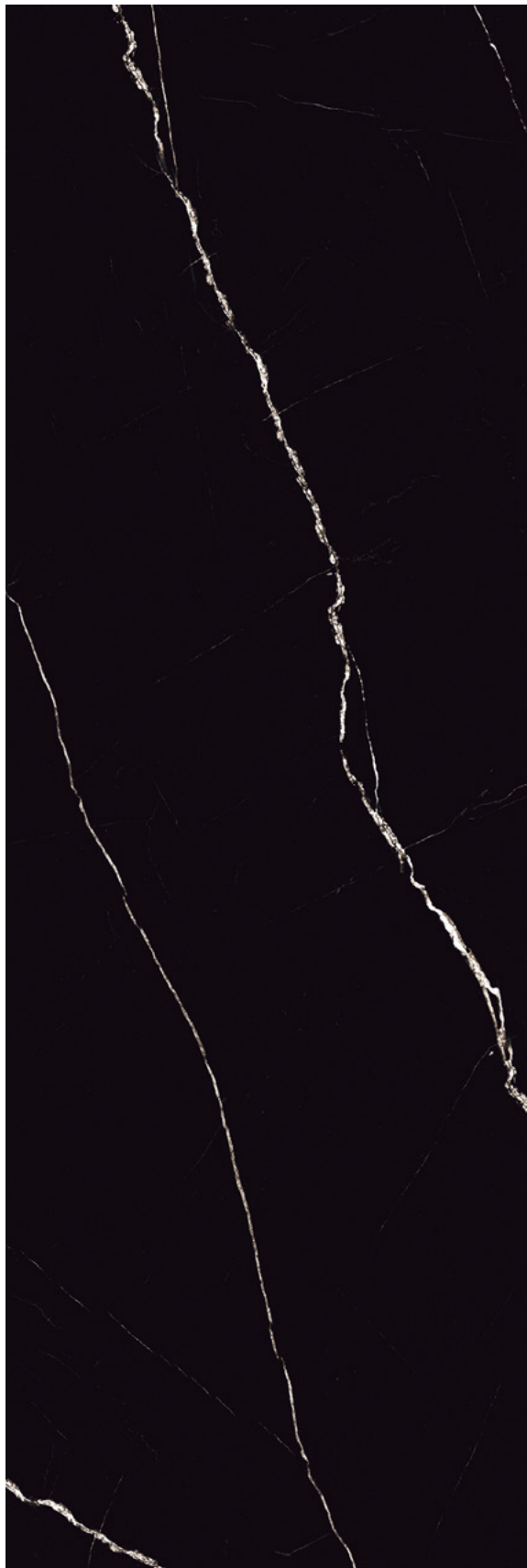

LABRADOR BLACK

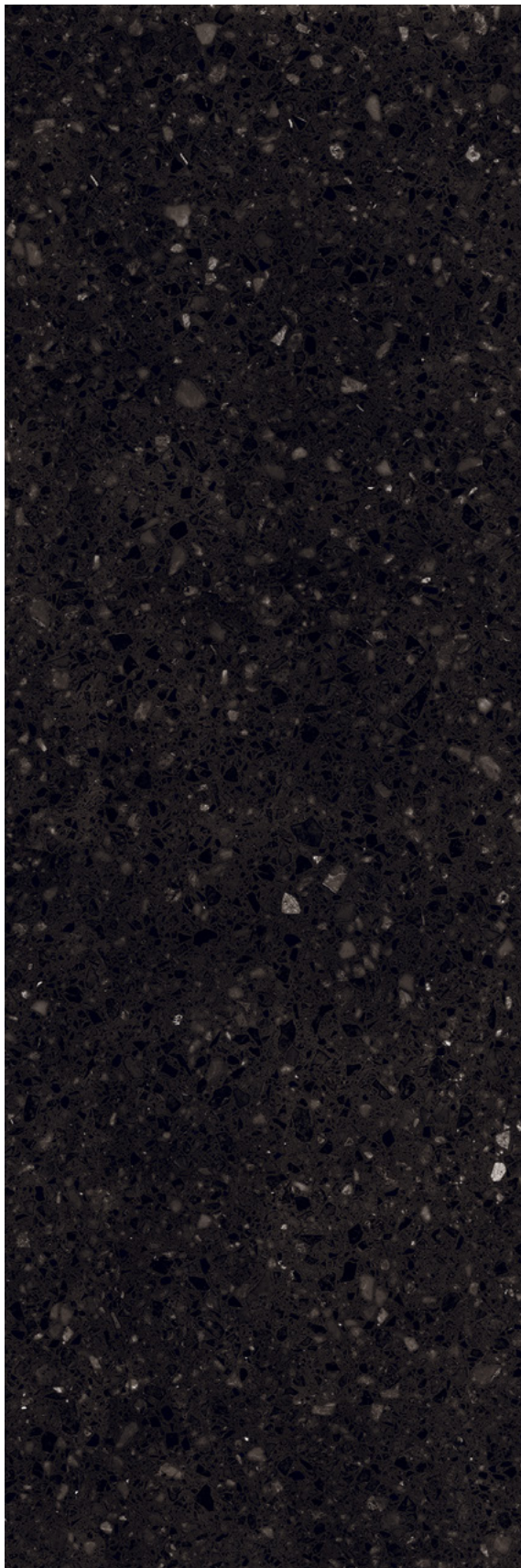

THICKNESS

15MM, 18 MM

SIZE

800X2400MM

FINISH

GLOSSY

EFFECT

MARBLE

ROSE BLACK



STATUARIO CALACATTA



THICKNESS

15MM, 18 MM

SIZE

800X2400MM

FINISH

GLOSSY

EFFECT

MARBLE

SCABAS

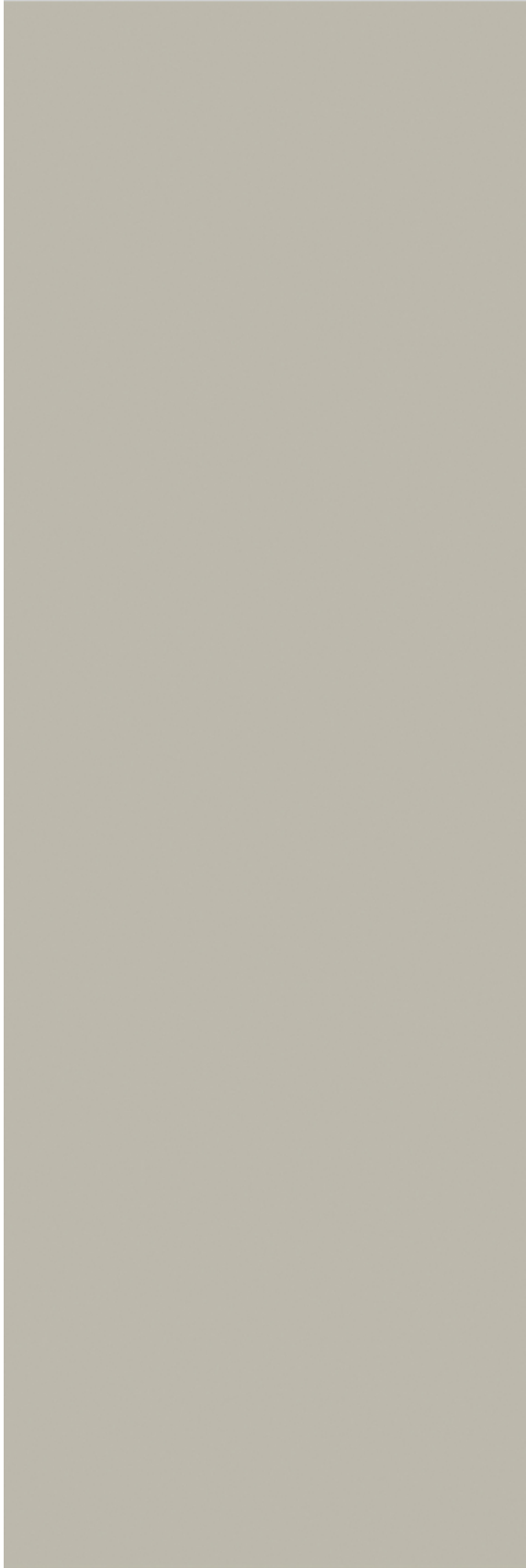

ROYAL QUARTZITE

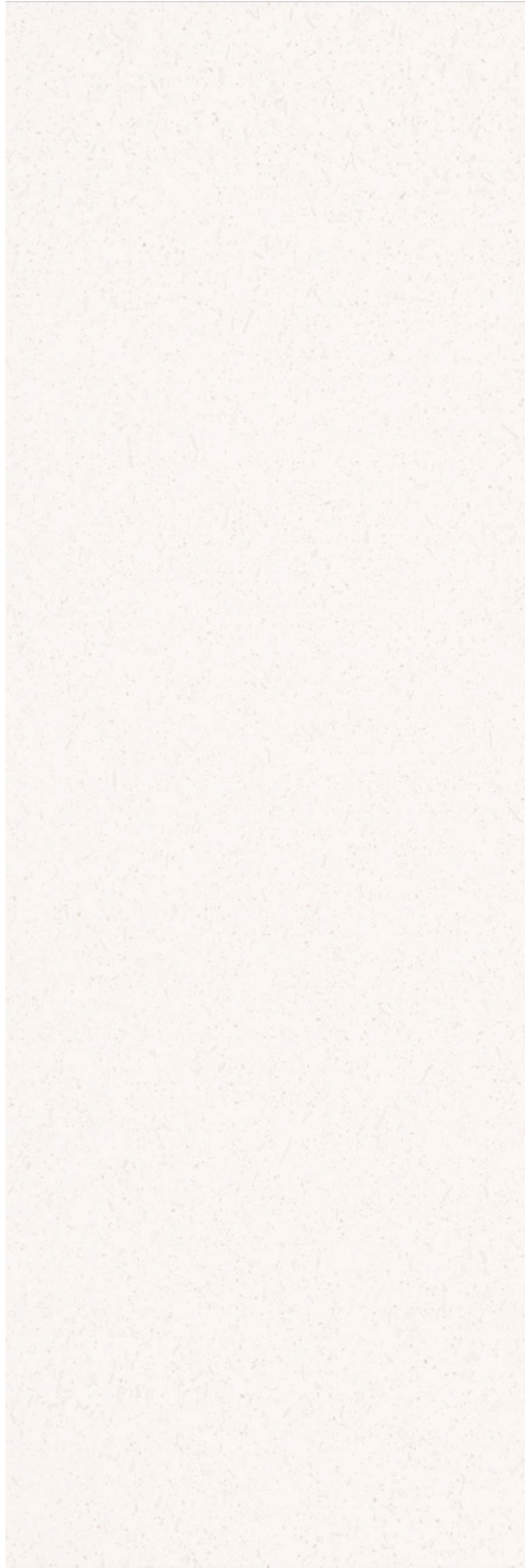

THICKNESS

15MM, 18 MM

SIZE

**800X2400MM
1200X2400MM**

FINISH

GLOSSY

EFFECT

MARBLE

STATUARIO LUCIDATO



STATUARIO PEARL



THICKNESS

15MM, 18 MM

SIZE

800X2400MM

FINISH

GLOSSY

EFFECT

MARBLE

TERAZZO BLACK FLAKES

TERAZZO BLACK SALT N PEPPER



THICKNESS

15MM, 18 MM

SIZE

**800X2400MM
1200X2400MM**

FINISH

GLOSSY

EFFECT

MARBLE

TERAZZO BROWN FLAKES



TERAZZO BROWN SALT N PPEPPER



THICKNESS

15MM, 18 MM

SIZE

**800X2400MM
1200X2400MM**

FINISH

GLOSSY

EFFECT

MARBLE

TERAZZO GREY SALT N PEPPER

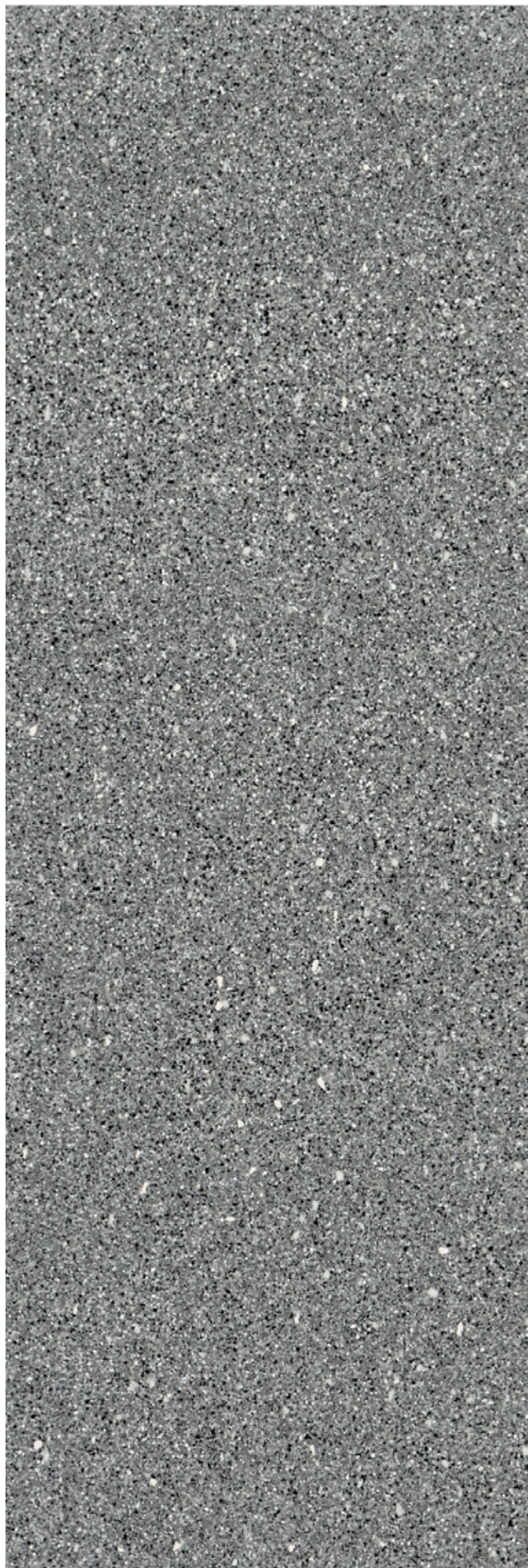

TERAZZO IVORY SALT N PEPPER



THICKNESS

15MM, 18 MM

SIZE

**800X2400MM
1200X2400MM**

FINISH

GLOSSY

EFFECT

MARBLE

TERAZZO VERDE SALT N PEPPER

WALL STREET GREY

WALNUT BROWN

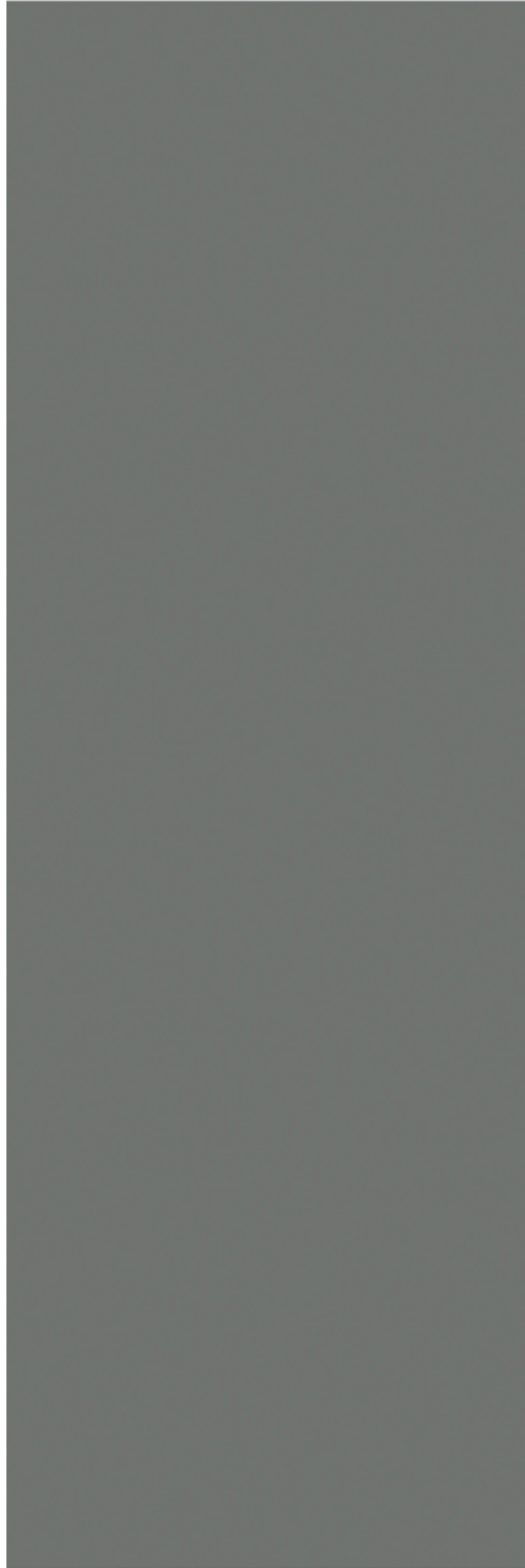

THICKNESS

15MM, 18 MM

SIZE

800X2400MM
1200X2400MM

FINISH

GLOSSY

EFFECT

MARBLE

TECHNICAL SPECIFICATION

CHARACTERISTICS	STANDARD AS PER ISO-13006/En14411 GROUP	VALUES	TEST METHOD
-----------------	--	--------	-------------

REGULATORY PROPERTIES

Deviation in Lenth & Width	0.50%	0.20%	ISO - 10545-2
Deviation in Thickness	0.50%	0.50%	ISO - 10545-2
Straightness of Sides	0.50%	0.20%	ISO - 10545-2
Rectangularity	0.50%	0.20%	ISO - 10545-2
Surface Flatness	0.50%	0.20%	ISO - 10545-2
Color Difference	Unaltered	No Change	ISO - 10545-16
Glossiness	As per Mfg.	>90%	Glossmeter

STRUCTURAL PROPERTIES

Water Absorption	<0.05%	<0.05%	ISO - 10545-3
Apparent Density	>2.00 g/cc	>2.10 g/cc	DIN 51082

MASSIVE MECHANICAL PROPERTIES

Modulus of Repture	Min 35N/MM2	Min 40N/MM2	ISO - 10545-4
Breaking Strength	Min. 1300 N	Min. 2000 N	ISO - 10545-4
Impact Resistance	As per Mfg.	Min. 0.55	ISO - 10545-5

SURFACE MECHANICAL PROPERTIES

Surface Abrasion Resistance	As per Mfg.	Min. class 3	ISO - 10545-7
Moh's Hardness	As per Mfg.	Min. class 4	EN 101

THERMO HYGROMETRIC PROPERTIES

Frost Resistance	No Damage	No Damage	ISO - 10545-12
Thermal Shock Resistance	No Damage	No Damage	ISO - 10545-09
Moisture Expansion	Nil	Nil	ISO - 10545-10
Thermal Expansion	Max 9.0x10 ⁻⁶	Max 6.5x10 ⁻⁶	ISO - 10545-08
Crazing Resistance	As per Mfg.	Min 10 Cycle	ISO - 10545-11

CHEMICAL PROPERTIES

Chemical Resistance	No Damage	No Damage	ISO - 10545-13
Stain Resistance	Resistant	Resistant	ISO - 10545-14

SAFETY PROPERTIES

Slip Resistance	As per Mfg.	>0.40	ISO - 10545-17
Fire Resistance	As per Mfg.	Fire Proof	N.A.

PACKING DETAIL

SIZE (in mm)	THICKNESS APPROX	PIECES / PER BOX	COVERAGE AREA IN SQ. FT	BOX WEIGHT (APPROX.)
800x2400 MM	15 MM	1	20.67	68 kgs
800x2400 MM	18 MM	1	20.67	81 kgs

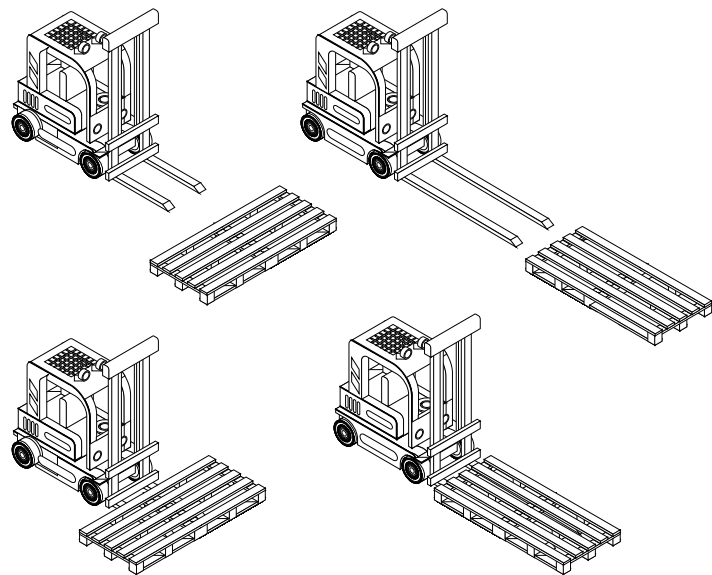

✓ RIGHT

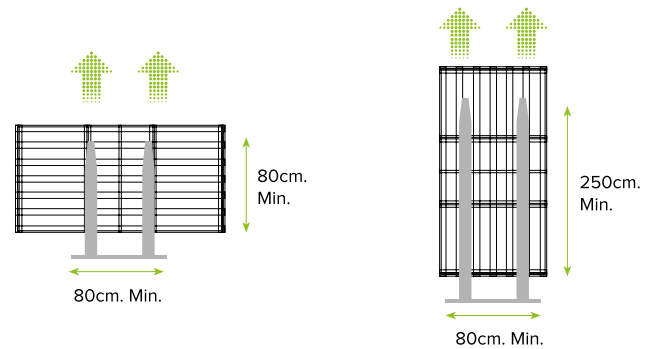
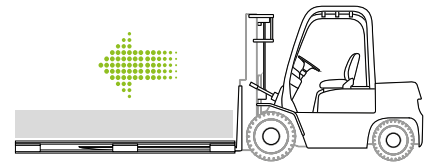

✗ WRONG

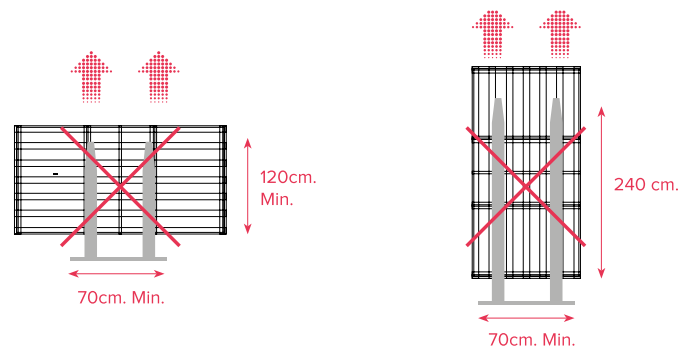
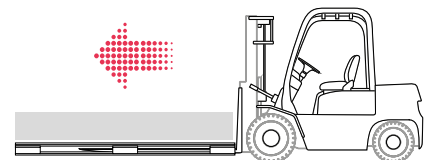

STORAGE

We should use a forklift truck, at least 2,5 mts. long, with the forks positioned in the largest width position, in order to handle the pallet on a proper way. Under normal conditions, the forks are positioned in the middle of the long side of the pallet, as they must hold the whole depth of the pallet. To allow the extraction of the slabs in a safe and easy way, it is recommended to position the pallets in a suitable area where the lift truck can be moved around all sides of the pallet.

HANDLING SLAB

Fab Slab's extra-large format slabs arrived in oversized crates, which require specific handling equipment. To prevent damage from occurring during forklift operation, specific fork sizes must be used. For example, to handle a crate of 135cm x 305cm tiles from the side, 112cm/44" long forks are recommended.

To handle the same crate from the narrow end requires forks that are at least 213cm/84" long. Lifting multiple crates with longer forks may require forklifts with a greater lift capacity.

Specialized tools and equipment are currently available for the handling and installation of large porcelain surfaces. Innovative trowels with unique notch configurations can help increase the consistency of the mortar coverage on the back of the tile.

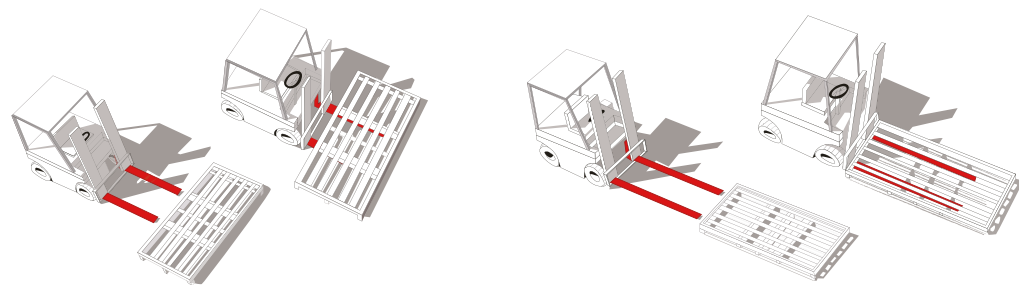

HANDLING EQUIPMENT

Handling device to free move 150X150 Slabs (use 2 for 305cm Slab)



Double Suction Cup 115 MM



Modular Bench BM 180



LEVELLING EQUIPMENT

RLS Clips for Tiles 10-12 MM thick (½" - ¾") - 400 pcs bag

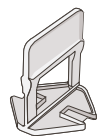

Wedges in 1000 pcs / carton

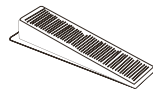

Adjustable pliers for wall and floor covering

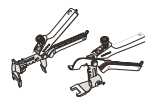

CUTTING EQUIPMENT

Free cut guide with complete outfit Max. cut of length-156 CM



Free cut extension length - 170 CM



Cutting of pillars for tiles/slabs Thickness 6-12 MM

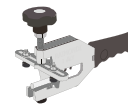

MECHANICAL FIXING EQUIPMENT

Fix Stainless Steel Hook for 8 MM thickness tiles - 500 pcs

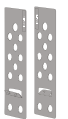

Cut Grooving Machine 850w-230v 50/60hz

