

1200X2400mm



COLLECTION 2020



Fab Slab

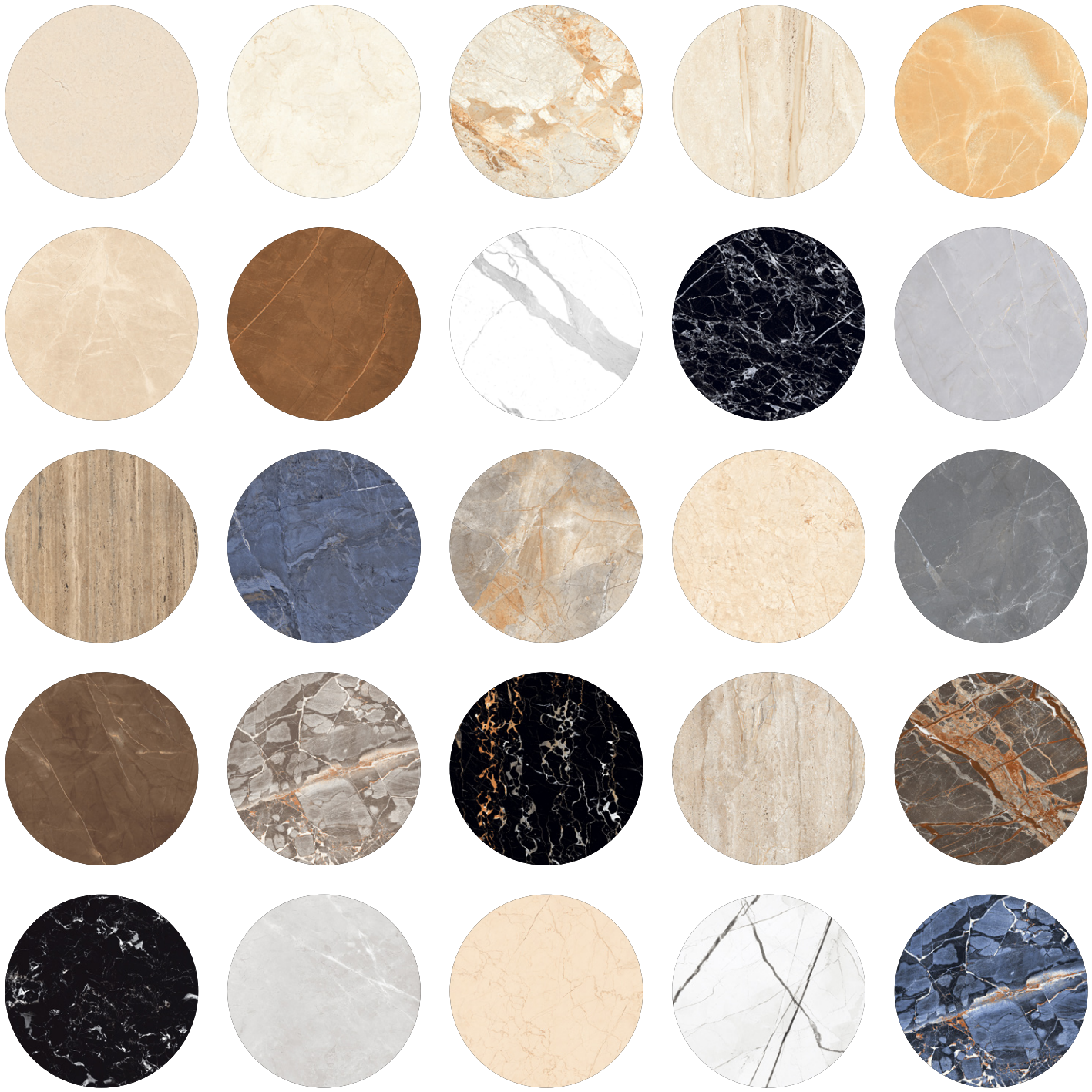

Fab Slab is a flourishing centre for Italian design and slabs. Fab Slab is a new conglomerate that offers a rich array of products and services in terms of design and manufacturing of slabs. Fab Slab represents unparalleled technical, artistic and organizational standards that distinguish it from its peers.

Fab Slab is the essence of years of rigorous research. In its core efforts, Fab Slab epitomizes the urge to establish new standards and norms in the industry. Over decades of experience has gone into the making of this ambitious venture that us set to revoutionize art and craft of manufacturing slabs. Based on ground-breaking research, Fab Slab has conceptualized its ravishing designs and world-class manufacturing process.

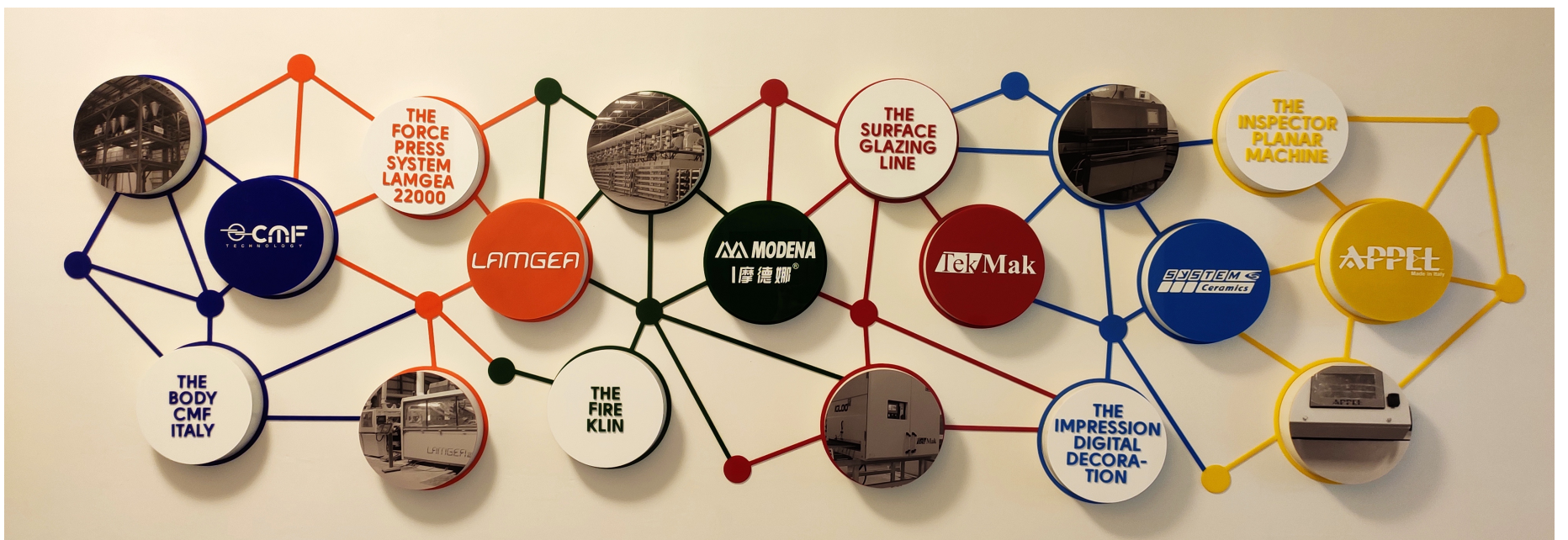



WHAT IS Fab Slab?

**STRENGTH PLUS
VERY LARGE SIZES AND
HIGH THICKNESS.**

An innovative and Italian quality porcelain slabs, ideal for kitchen countertops, bathroom countertops, furniture, flooring and wall applications. The perfect combination of quality and wide collections of texture surface like marble, stone, wood, metal & concrete.

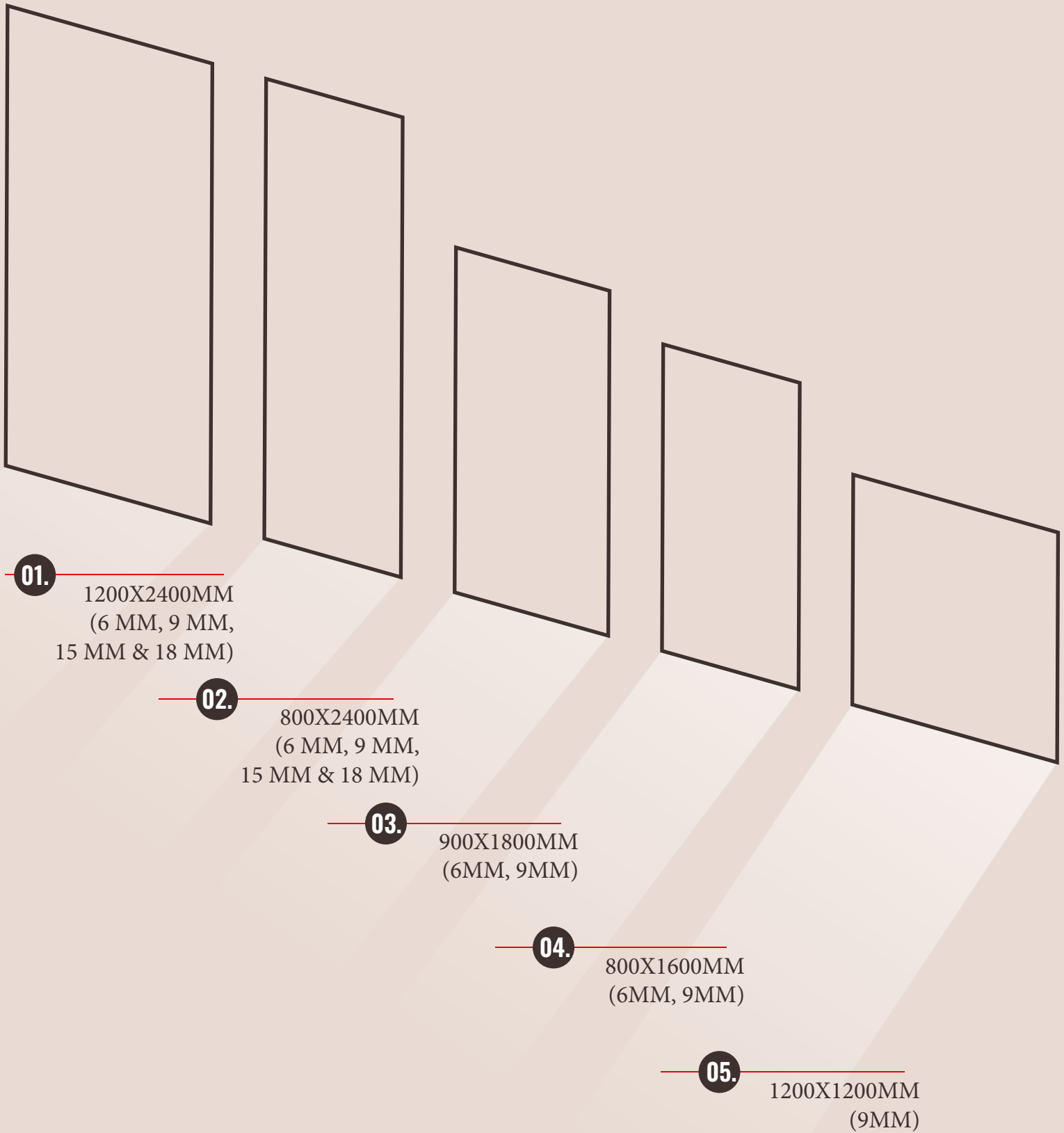

Specific answers to any need.
5 sizes, 4 thickness options

APPLICATION



AIRPORT



RESTAURANT



FITTED KITCHEN AND
BATHROOM FURNITURE



HOTELS



RETAIL MALLS



SPA AND WELLNESS
CENTRES



OFFICES



SHOPS



MUSEUMS



VENTILATED CURTAIN
WALLS



HOMES



INTERIOR DESIGN
AND FURNISHINGS

NEW PRODUCTION TECHNOLOGIES BRING UP THE CHALLENGE OF CREATING MATERIALS CAPABLE OF SHAPING THE SPACE TECHNICALLY AND ESTHETICLY IN AN EFFICIENT WAY.

Fab Slab, a brand born to provide advanced solutions to architecture and interior design. Materials that offer unlimited versatility in all fields of construction, furniture, design, etc.

FEATURES



HIGHLY UV
RESISTANT



RESISTANT TO
SCRATCHES



WATERPROOF



RESISTANCE TO
CHEMICAL ATTACK



LIGHTNESS



LIGHTNESS



FROST
RESISTANCE



RESISTANT TO
STAINS



RECYCLABLE



EASY TO CLEAN



FIREPROOF

POSSIBILITIES

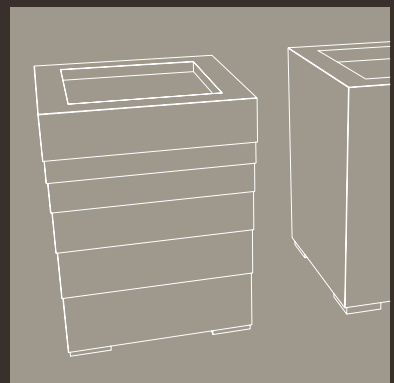
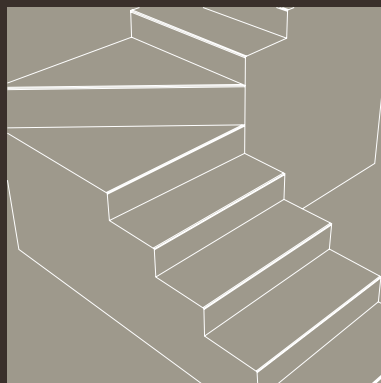
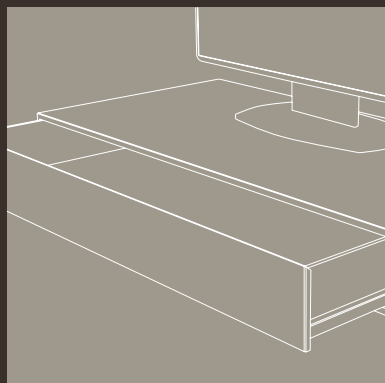
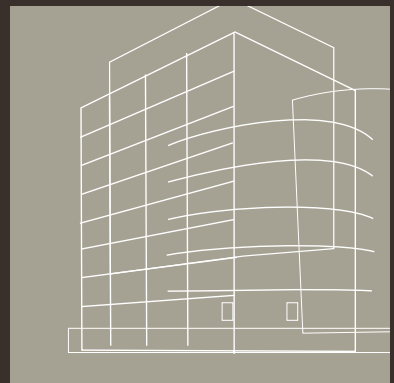
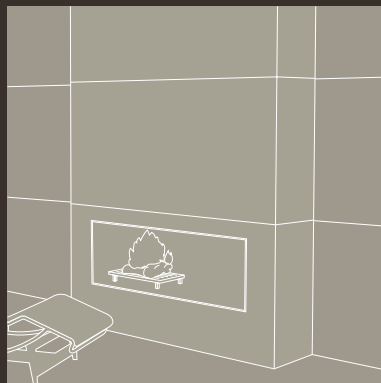
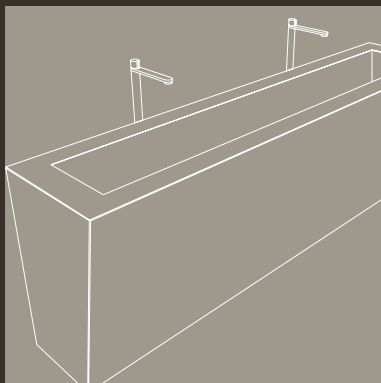
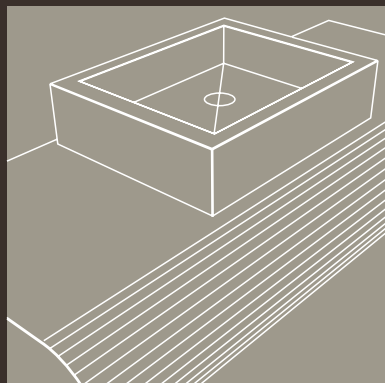
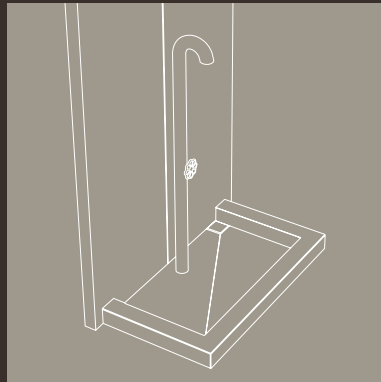
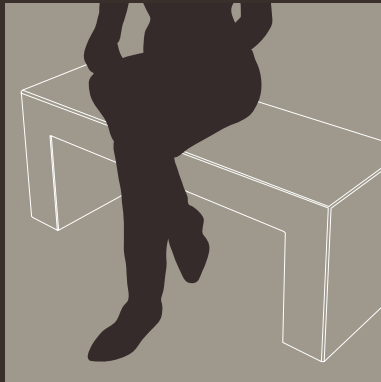
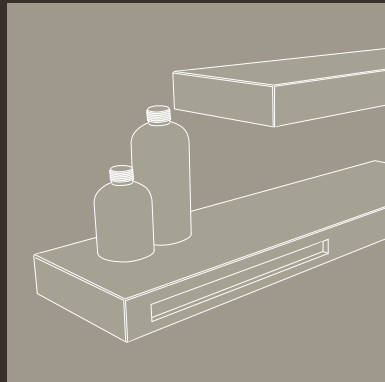

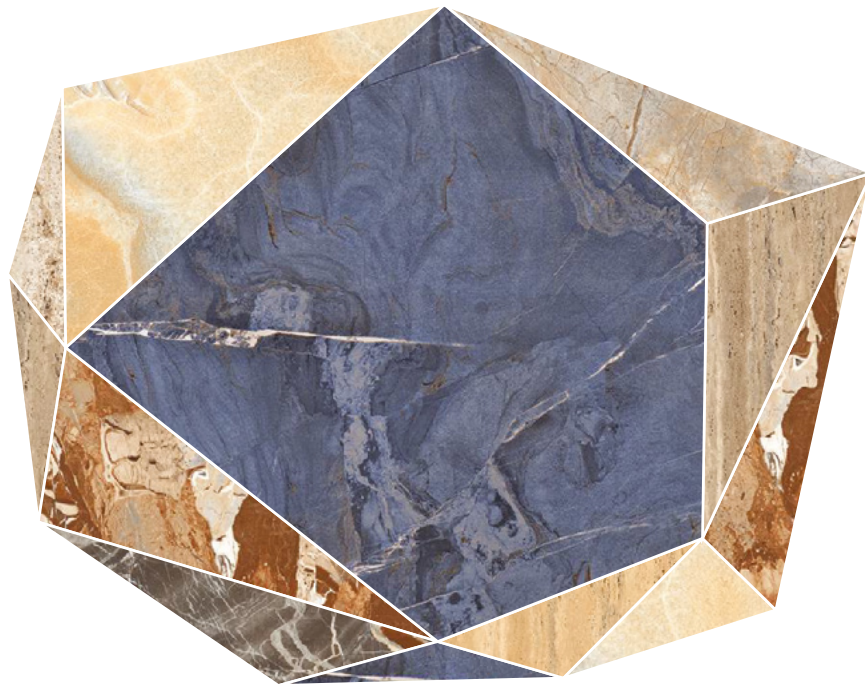

FINISH



GLOSSY

ALLURE

RANDOM

2

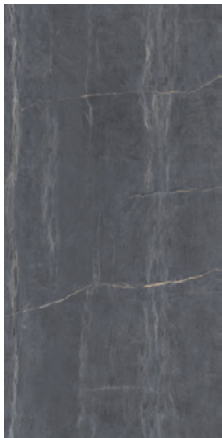

ANTRESIT BEIGE

RANDOM

3



THICKNESS

6MM, 9 MM

SIZE

1200X2400MM

FINISH

GLOSSY

EFFECT

MARBLE

ANTRESIT BIANCO

RANDOM

3



ANTRESIT GREY

RANDOM

3



THICKNESS

6MM, 9 MM

SIZE

1200X2400MM

FINISH

GLOSSY

EFFECT

MARBLE

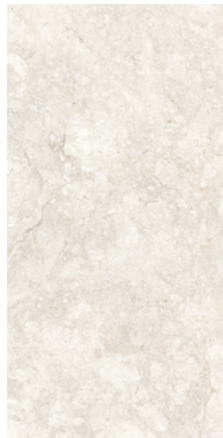

ICEY BROWN

RANDOM

7



THICKNESS

6MM, 9 MM

SIZE

1200X2400MM

FINISH

GLOSSY

EFFECT

MARBLE



ICEY GREY

RANDOM

7



THICKNESS

6MM, 9 MM

SIZE

1200X2400MM

FINISH

GLOSSY

EFFECT

MARBLE



BALVAGIRI BEIGE

RANDOM

2

BELVEDRE PELLE

RANDOM

2

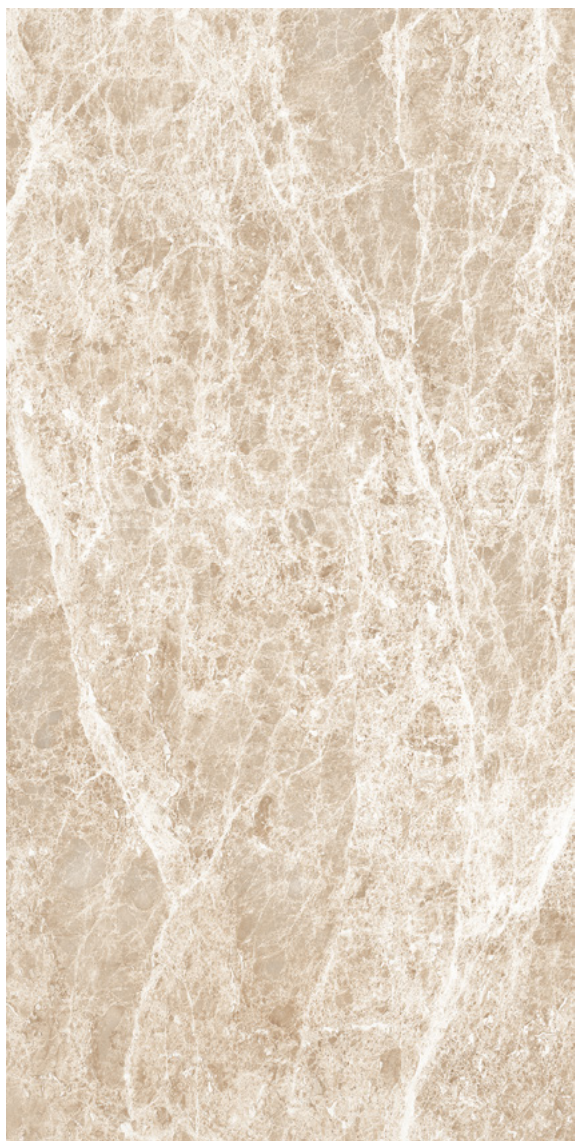

THICKNESS

6MM, 9 MM

SIZE

1200X2400MM

FINISH

GLOSSY

EFFECT

MARBLE

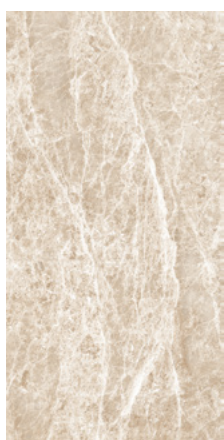

**BIANCO STATUARIO
VENATO**

RANDOM

4

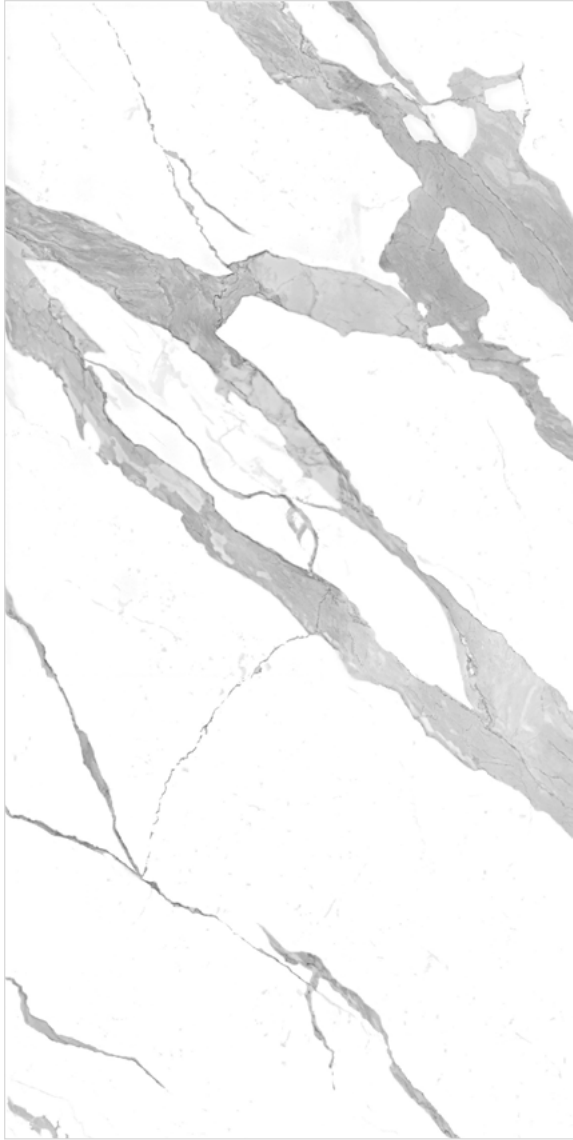

BLACK BEAUTY

RANDOM

2

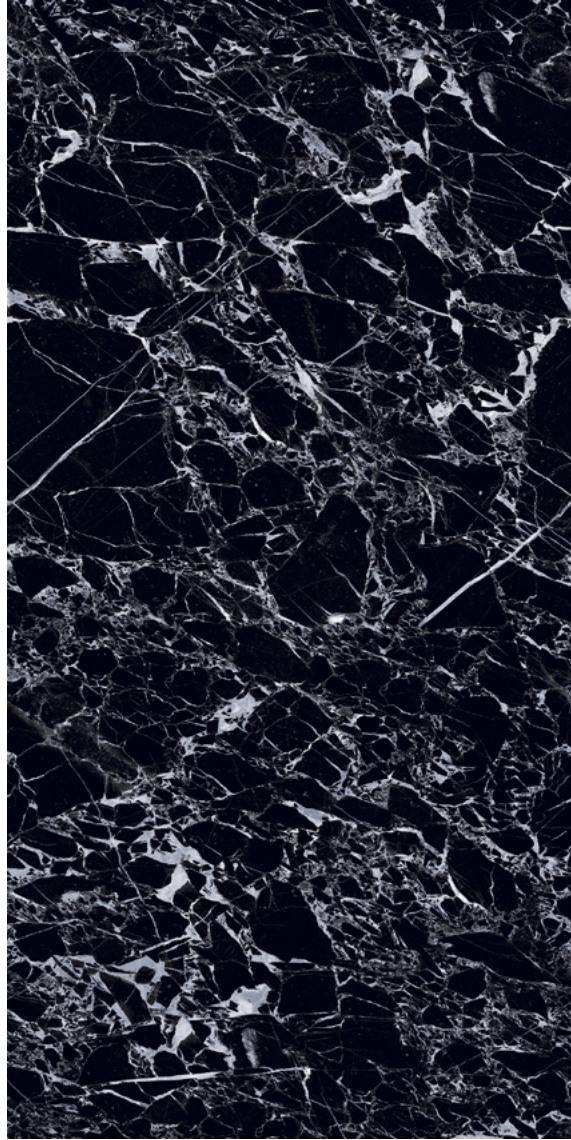

THICKNESS

6MM, 9 MM

SIZE

1200X2400MM

FINISH

GLOSSY

EFFECT

MARBLE

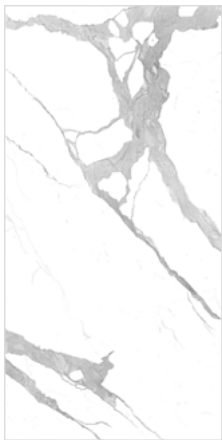
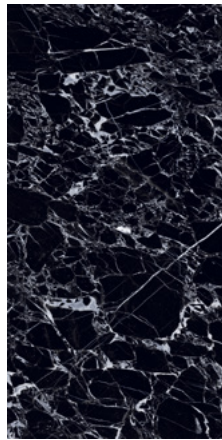
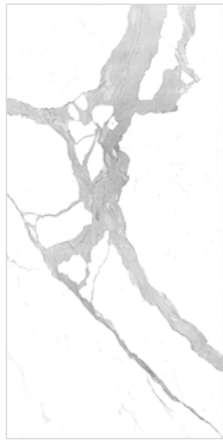
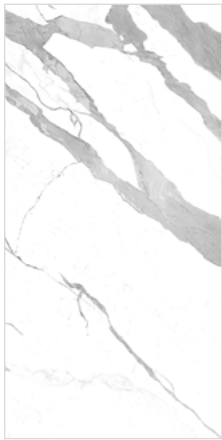

BLACK PEARL

RANDOM

6



THICKNESS

6MM, 9 MM

SIZE

1200X2400MM

FINISH

GLOSSY

EFFECT

MARBLE

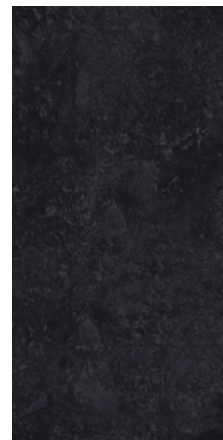
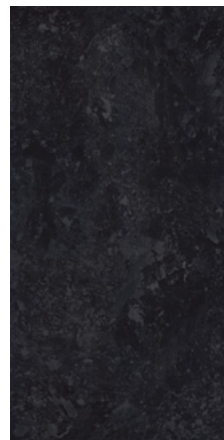
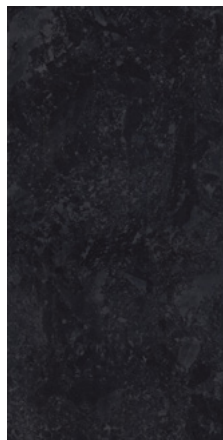
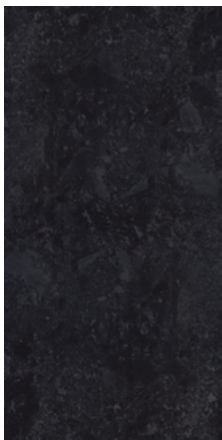

BLUE PRECIOUS WOOD

RANDOM

1

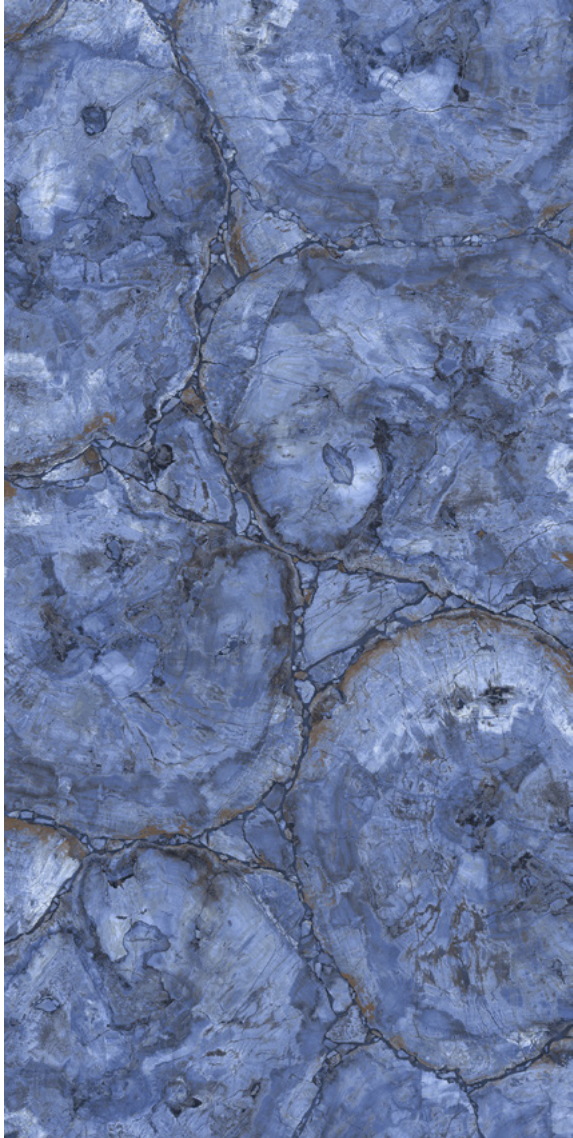

**BOTTOCHINO CLASSICO
BEIGE**

RANDOM

5



THICKNESS

6MM, 9 MM

SIZE

1200X2400MM

FINISH

GLOSSY

EFFECT

MARBLE



BOTTOCINO FIORTO

RANDOM

3

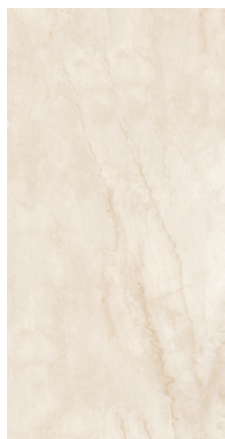

BRECCIA AURORA

RANDOM

3

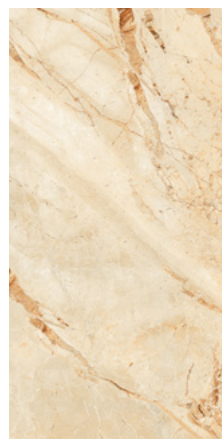
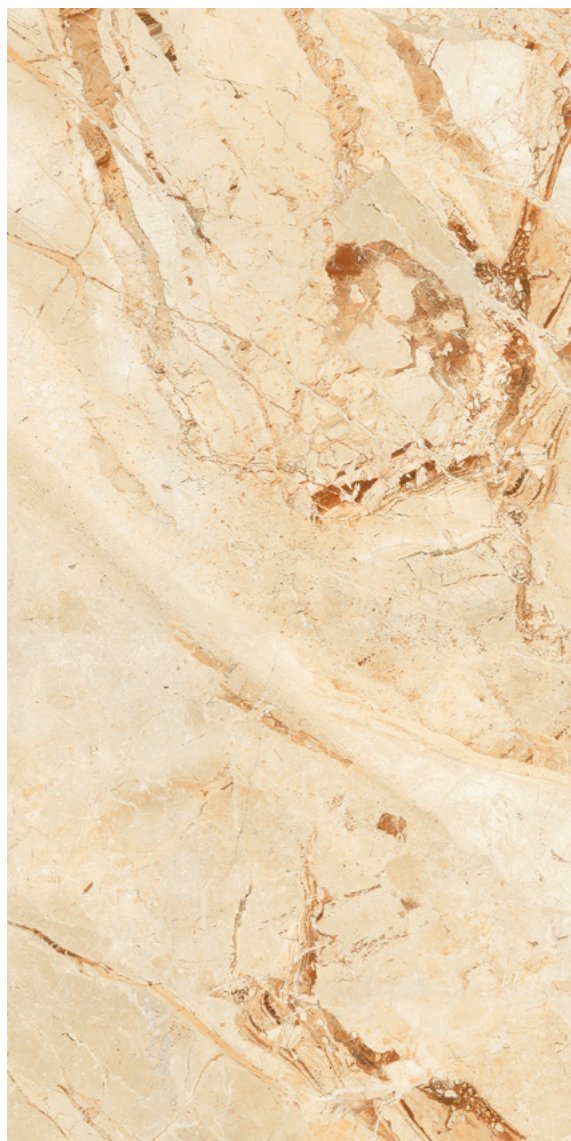

THICKNESS

6MM, 9 MM

SIZE

1200X2400MM

FINISH

GLOSSY

EFFECT

MARBLE

BRECCIA BEIGE

RANDOM

3



CALACATTA

RANDOM

2

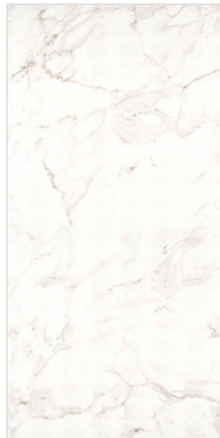
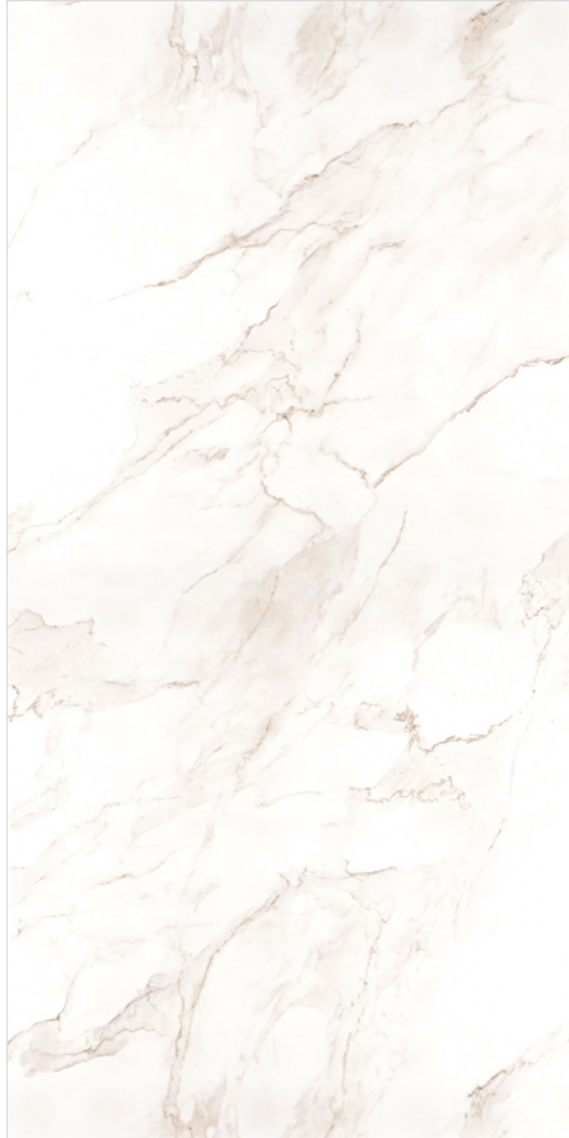

THICKNESS

6MM, 9 MM

SIZE

1200X2400MM

FINISH

GLOSSY

EFFECT

MARBLE

CARACUS GREY

RANDOM

1

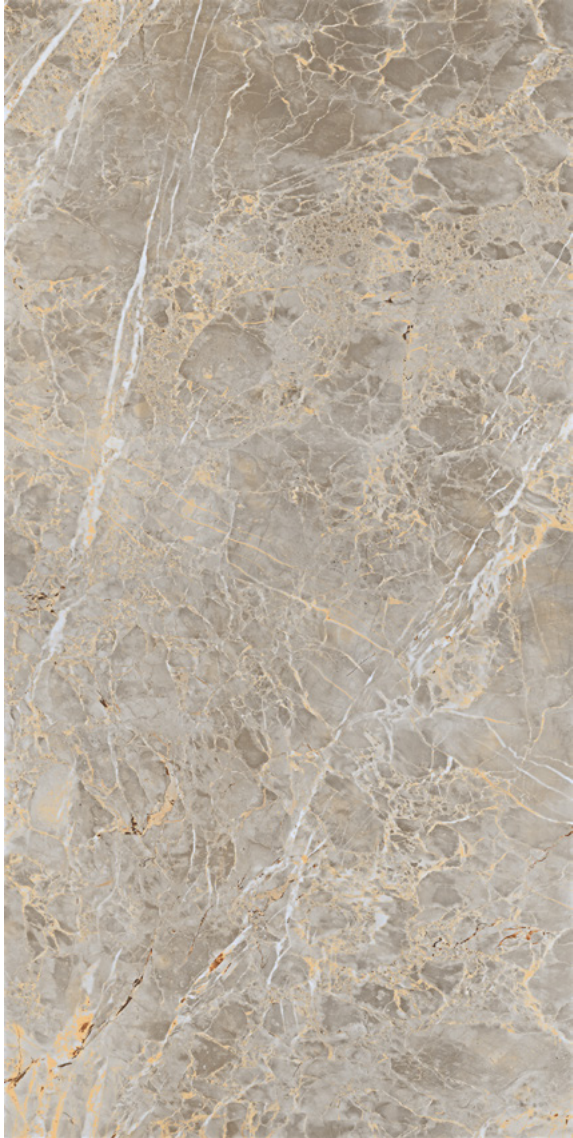

CARRARA BORGHINI

RANDOM

4



THICKNESS

6MM, 9 MM

SIZE

1200X2400MM

FINISH

GLOSSY

EFFECT

MARBLE

CASA BLANCA

RANDOM

COSMOS

RANDOM

2

2



THICKNESS

6MM, 9 MM

SIZE

1200X2400MM

FINISH

GLOSSY

EFFECT

MARBLE

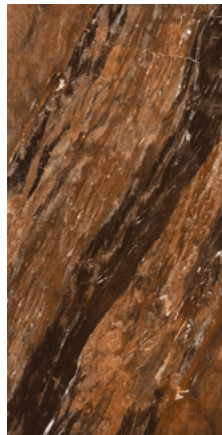

CREMA MARFIL

RANDOM

3



CRYSTAL ONICO

RANDOM

2

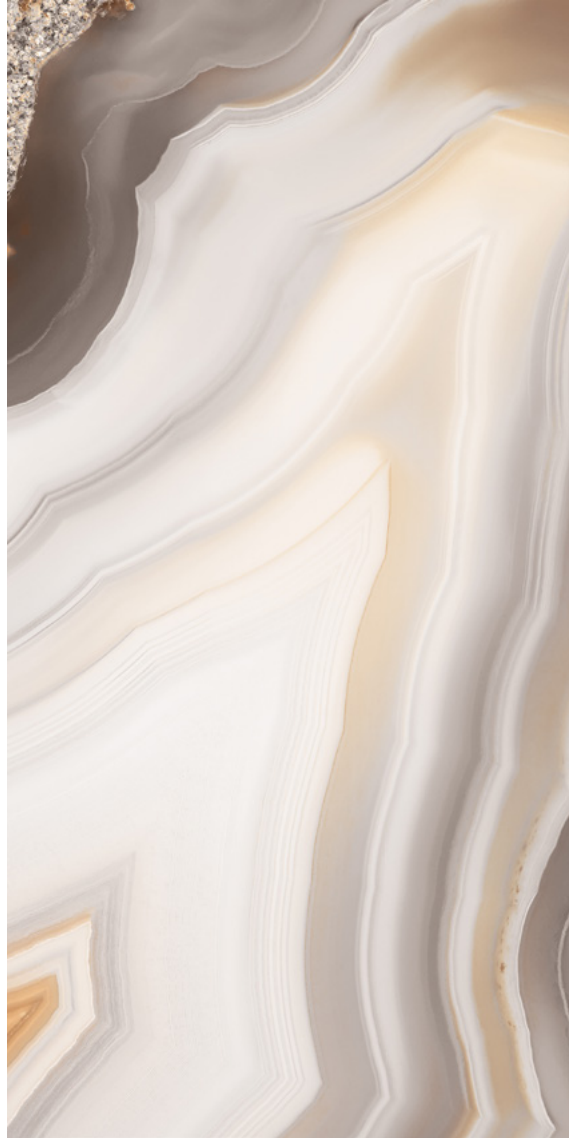

THICKNESS

6MM, 9 MM

SIZE

1200X2400MM

FINISH

GLOSSY

EFFECT

MARBLE

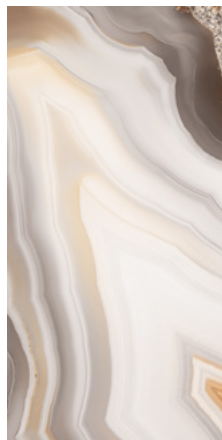
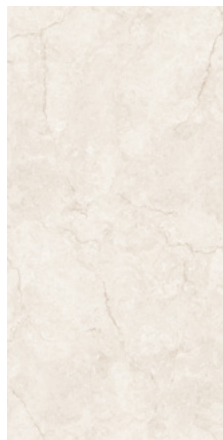
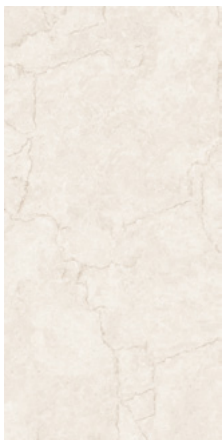

DYNA NATURAL

RANDOM

5

EMPERADOR MARRON

RANDOM

2

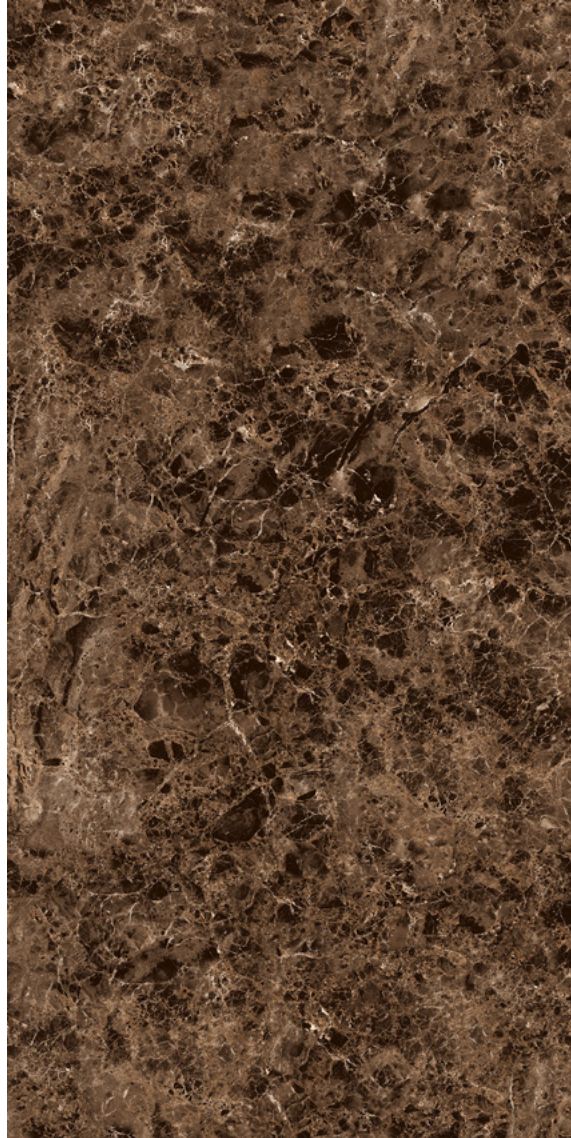

THICKNESS

6MM, 9 MM

SIZE

1200X2400MM

FINISH

GLOSSY

EFFECT

MARBLE

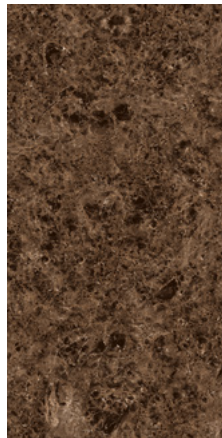

EMPERADOR QUARTZ

RANDOM

2

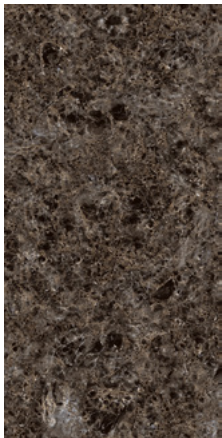
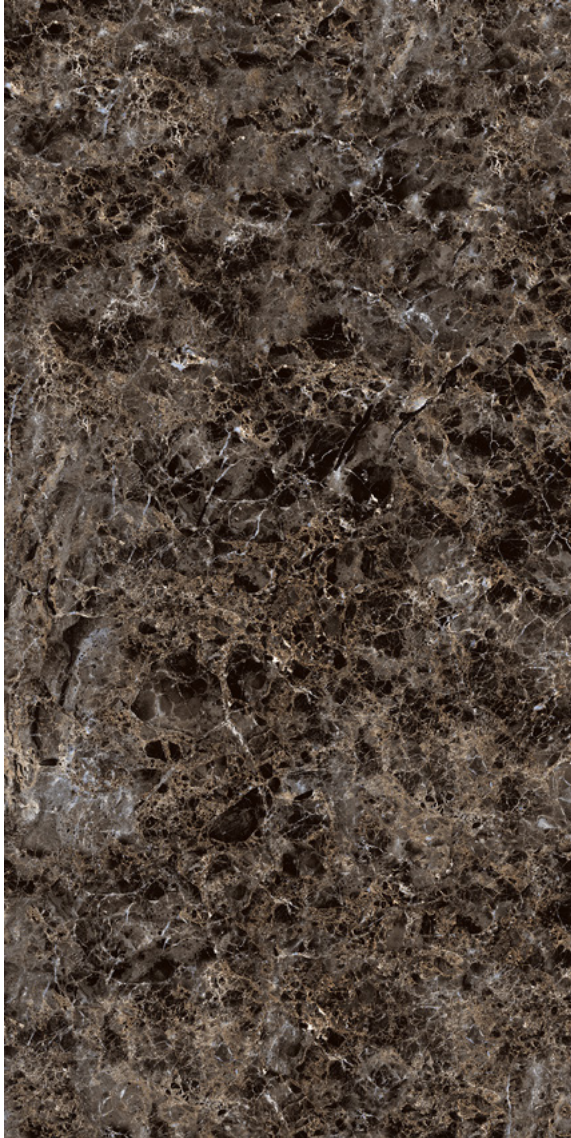

EXOTIC TAJ BOOK MATCH

RANDOM

2



THICKNESS

6MM, 9 MM

SIZE

1200X2400MM

FINISH

GLOSSY

EFFECT

MARBLE

FLORENCE WHITE

RANDOM

3

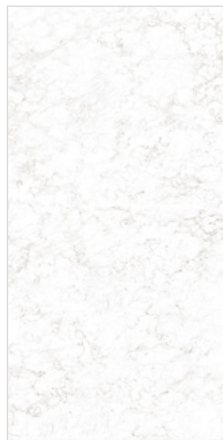

FRENCH PORCELAIN

RANDOM

2

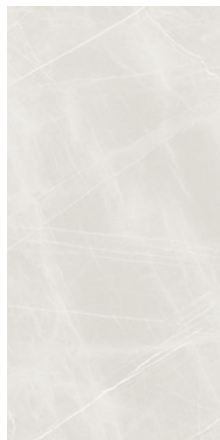

THICKNESS

6MM, 9 MM

SIZE

1200X2400MM

FINISH

GLOSSY

EFFECT

MARBLE

FRENCH SILVER

RANDOM

GREY MILANO

RANDOM

2

2



THICKNESS

6MM, 9 MM

SIZE

1200X2400MM

FINISH

GLOSSY

EFFECT

MARBLE

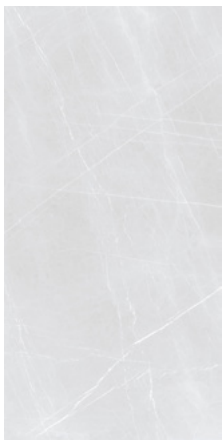

LAVA SATATUARIO

RANDOM

3



LORENZ CREMA

RANDOM

2



THICKNESS

6MM, 9 MM

SIZE

1200X2400MM

FINISH

GLOSSY

EFFECT

MARBLE

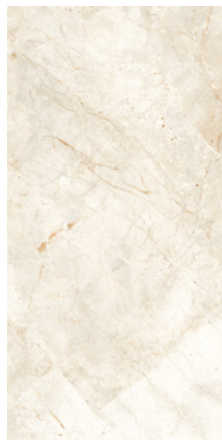
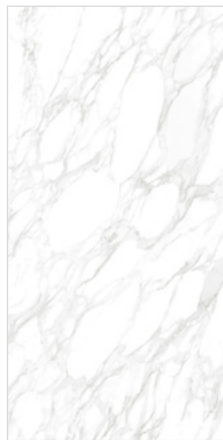

LORENZ WHITE

RANDOM

LOURENT GOLD

RANDOM

2

2

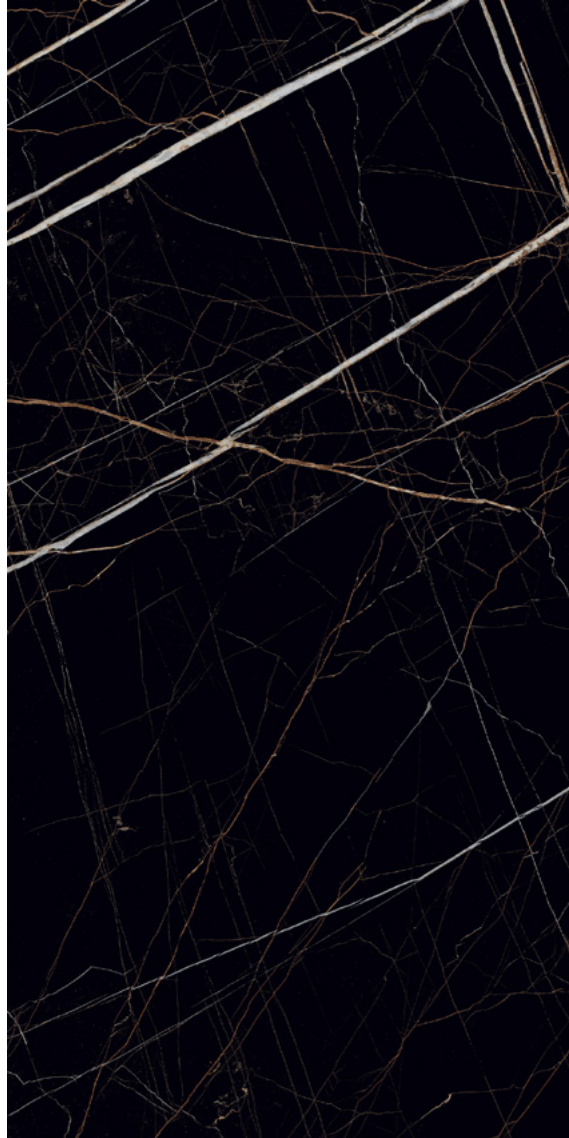

THICKNESS

6MM, 9 MM

SIZE

1200X2400MM

FINISH

GLOSSY

EFFECT

MARBLE

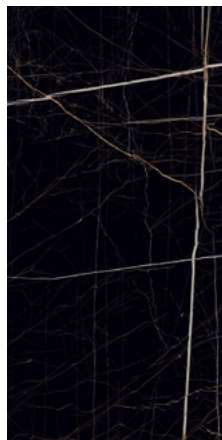
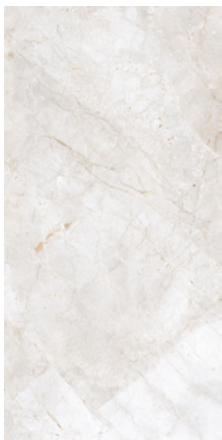

MARFIL BEIGE

RANDOM

3

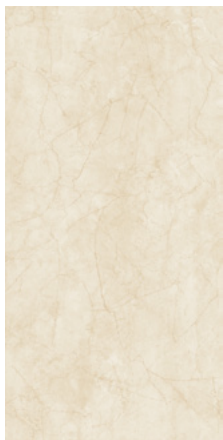
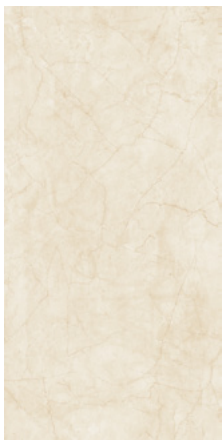

NOIR DESIRLUCIDATO

RANDOM

4

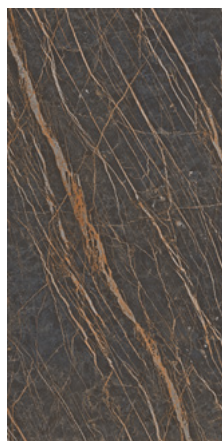
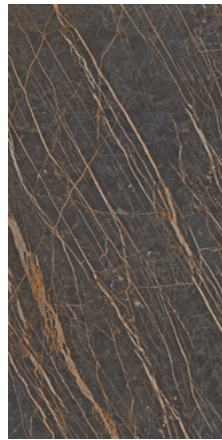
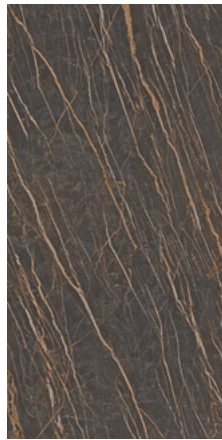

THICKNESS

6MM, 9 MM

SIZE

1200X2400MM

FINISH

GLOSSY

EFFECT

MARBLE

NOVELLE CREMA

RANDOM

2



NOVELLE ICE

RANDOM

2

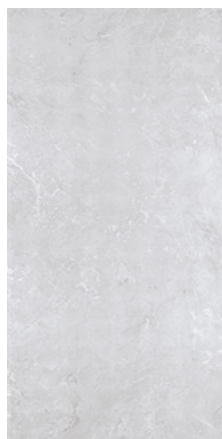

THICKNESS

6MM, 9 MM

SIZE

1200X2400MM

FINISH

GLOSSY

EFFECT

MARBLE

OCEAN ONYX

RANDOM

ORIENT BEIGE

RANDOM

2

2

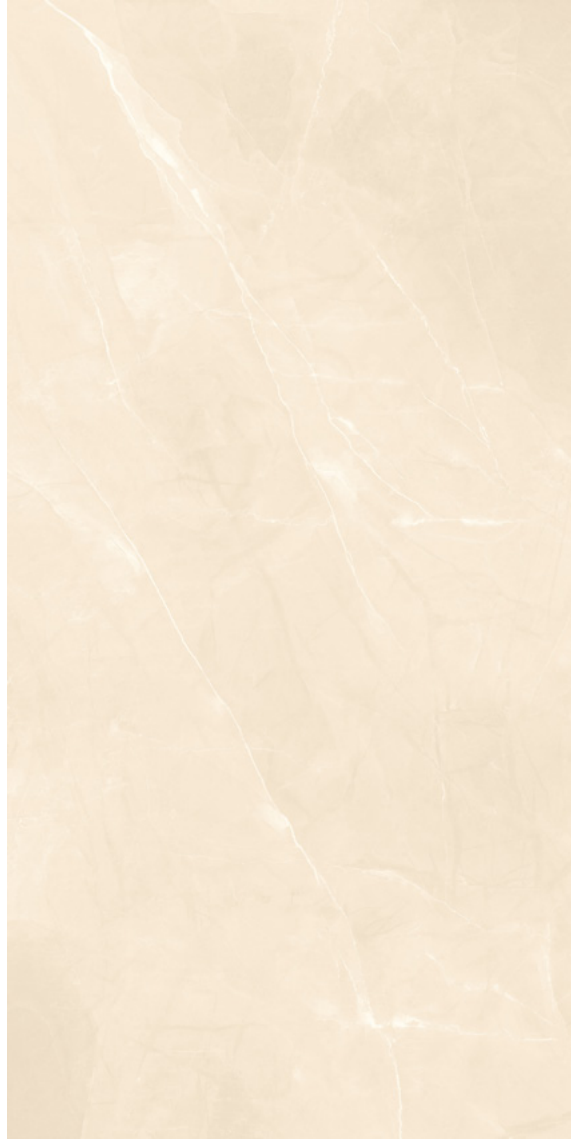

THICKNESS

6MM, 9 MM

SIZE

1200X2400MM

FINISH

GLOSSY

EFFECT

MARBLE

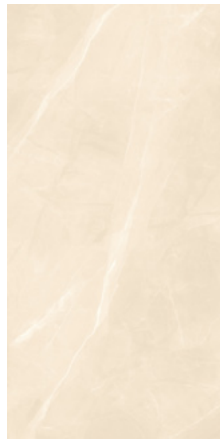

ORIENT BROWN

RANDOM

OROBICO GREY

RANDOM

2

2

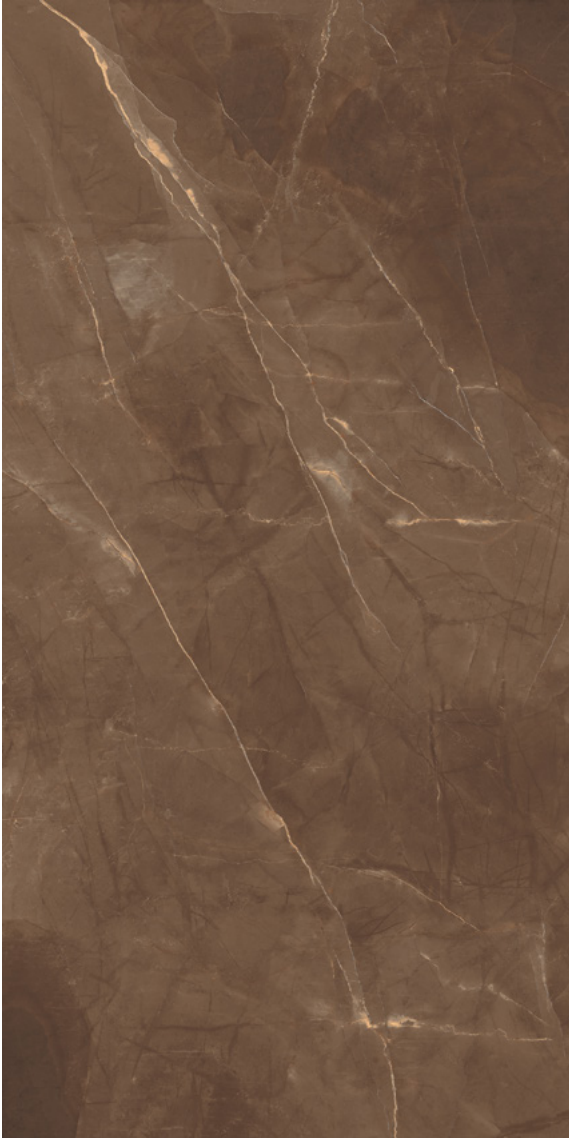

THICKNESS

6MM, 9 MM

SIZE

1200X2400MM

FINISH

GLOSSY

EFFECT

MARBLE

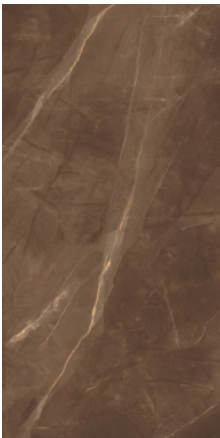

PIETRA GREYLUCIDATO

RANDOM

4



PRECIOUS WOOD

RANDOM

1

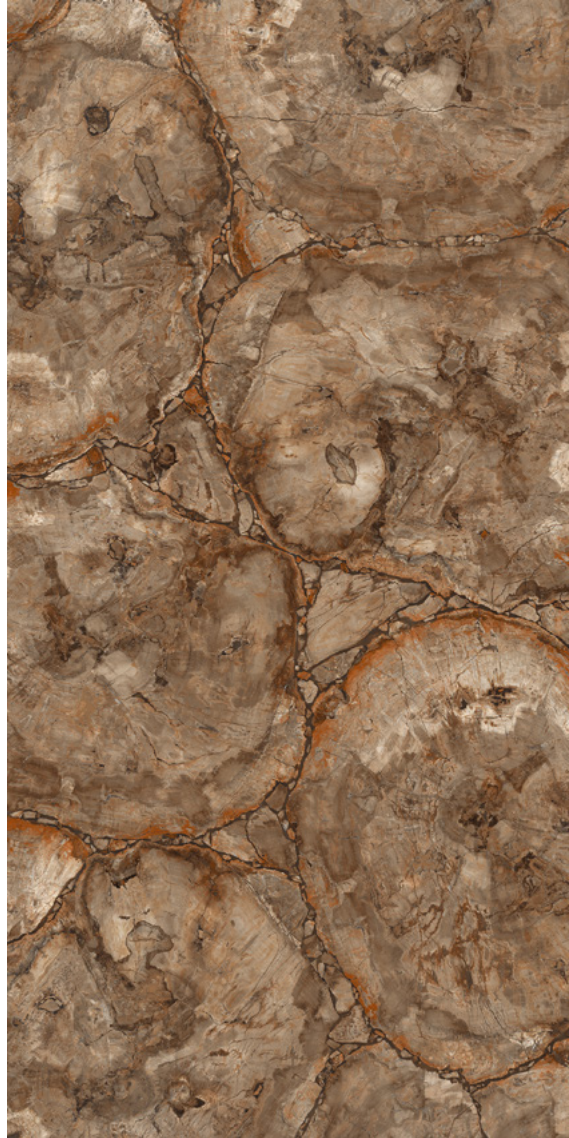

THICKNESS

6MM, 9 MM

SIZE

1200X2400MM

FINISH

GLOSSY

EFFECT

MARBLE

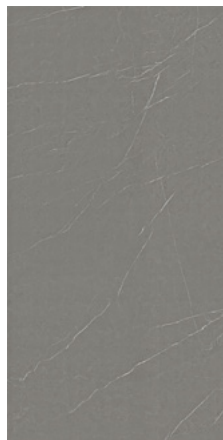

ROSE BLACK

RANDOM

SAPPHIRE GRAY

RANDOM

4

3

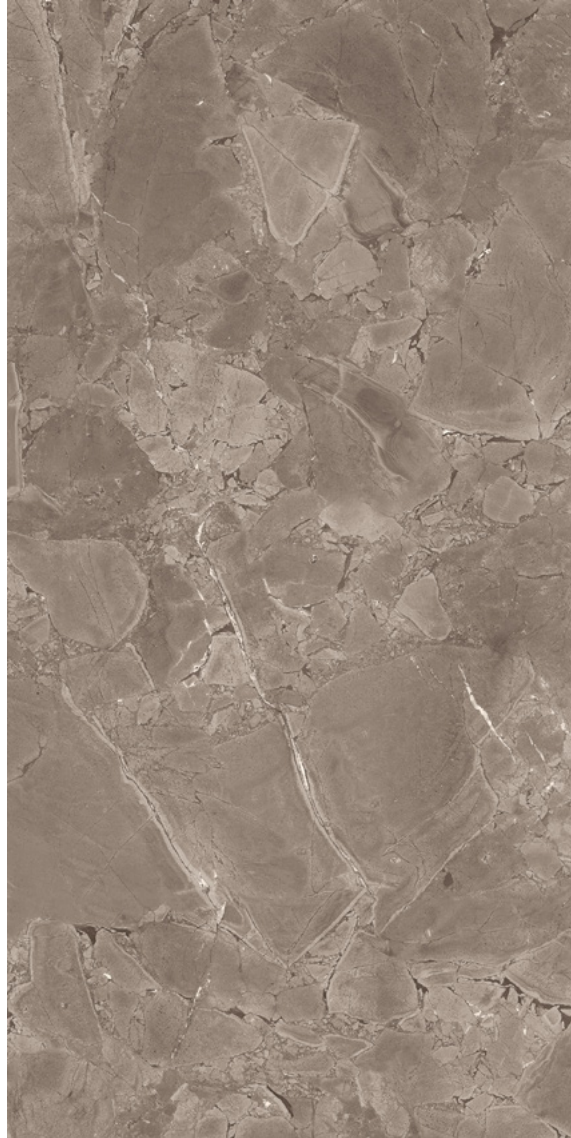

THICKNESS

6MM, 9 MM

SIZE

1200X2400MM

FINISH

GLOSSY

EFFECT

MARBLE

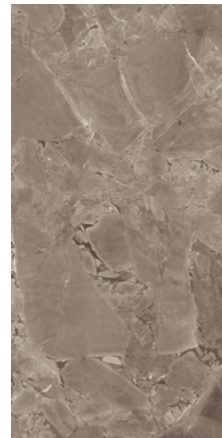
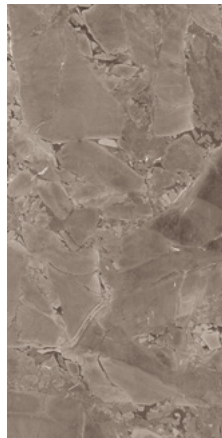
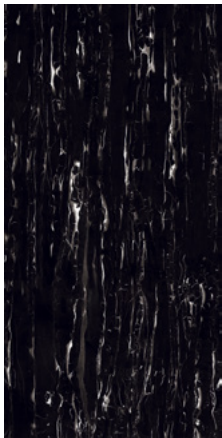

SATUARIO FANTASTICO

RANDOM

2



SATUARIO PEARL

RANDOM

3

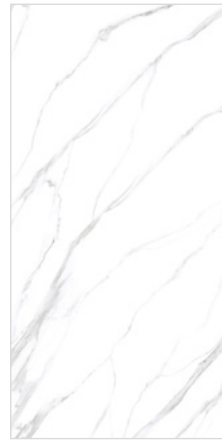
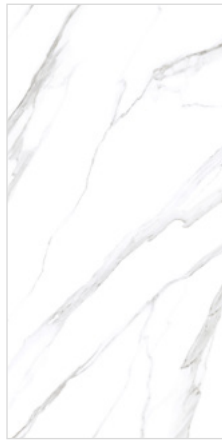
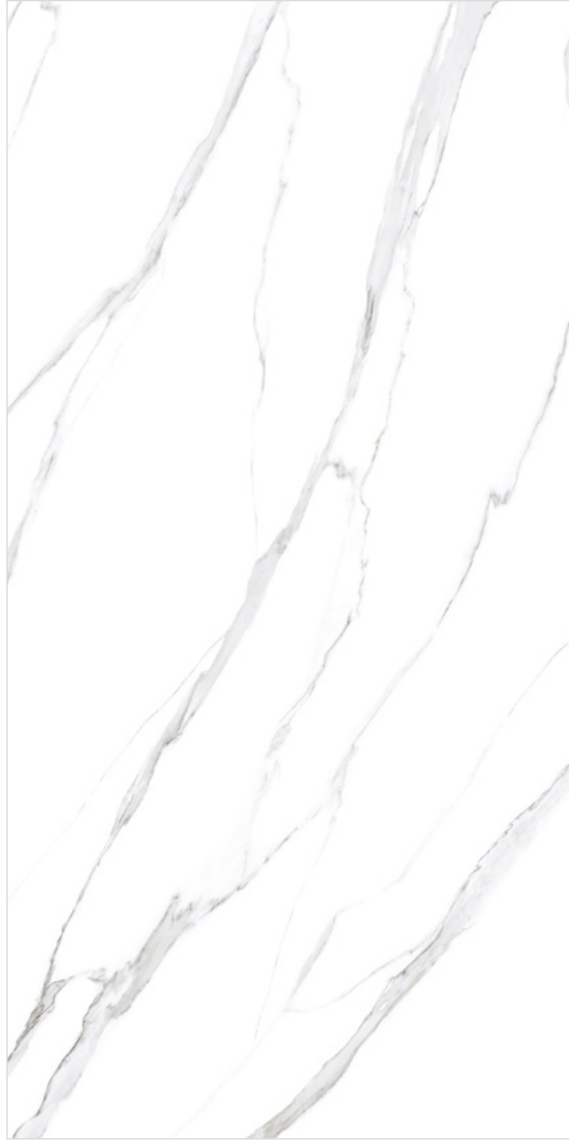

THICKNESS

6MM, 9 MM

SIZE

1200X2400MM

FINISH

GLOSSY

EFFECT

MARBLE

SMOKE GREY

RANDOM

2

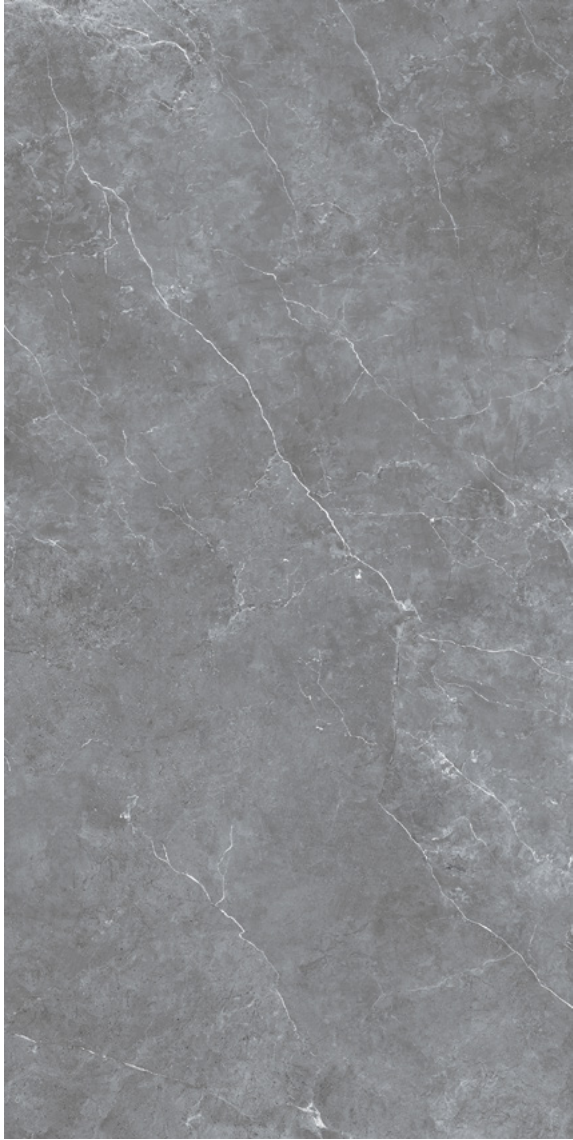

STATUARIO ICE

RANDOM

3



THICKNESS

6MM, 9 MM

SIZE

1200X2400MM

FINISH

GLOSSY

EFFECT

MARBLE

STATUARIO LUCIDATO

RANDOM

6

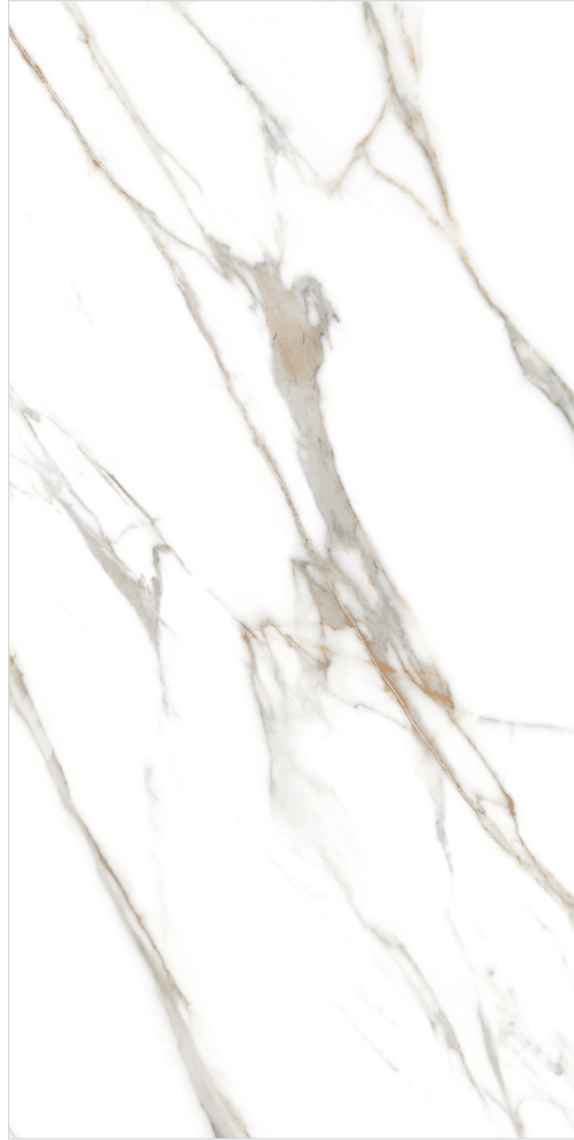

THICKNESS

6MM, 9 MM

SIZE

1200X2400MM

FINISH

GLOSSY

EFFECT

MARBLE

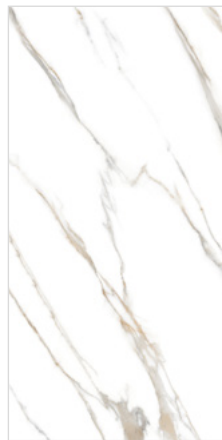
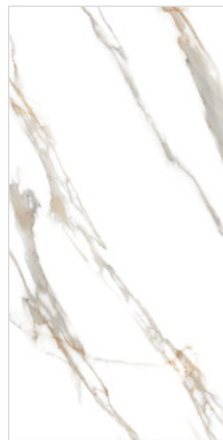
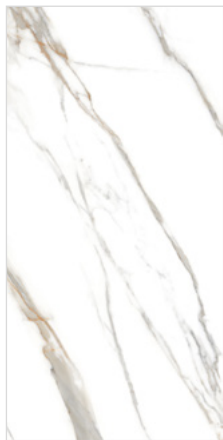
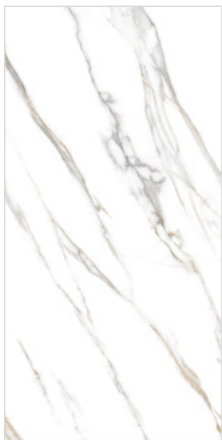

STATUARIO SUPER

RANDOM

2



WHITE ONYX

RANDOM

2

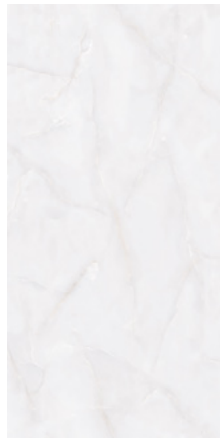
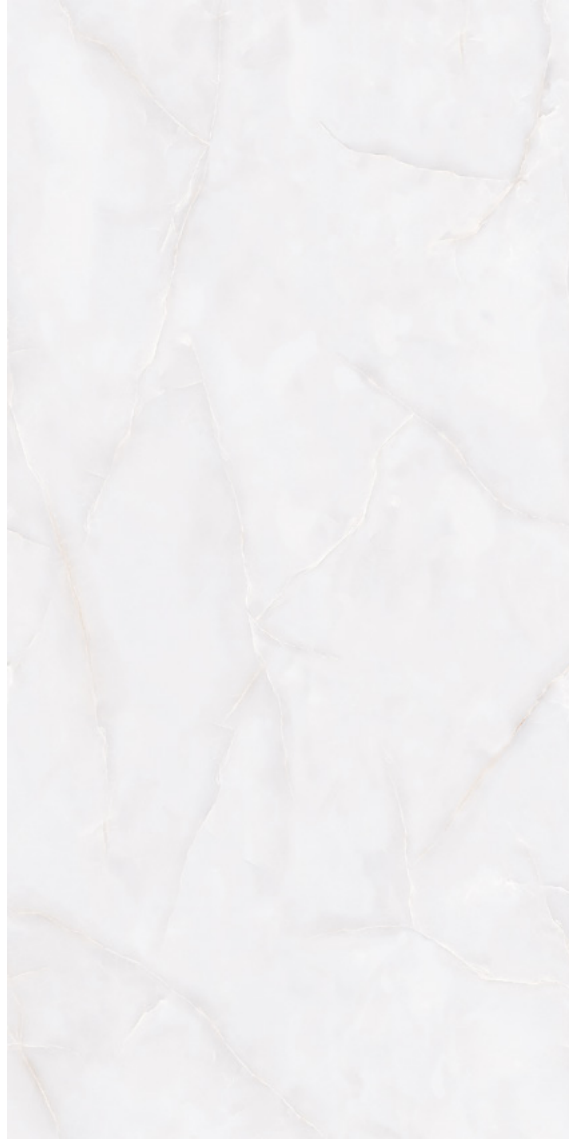

THICKNESS

6MM, 9 MM

SIZE

1200X2400MM

FINISH

GLOSSY

EFFECT

MARBLE

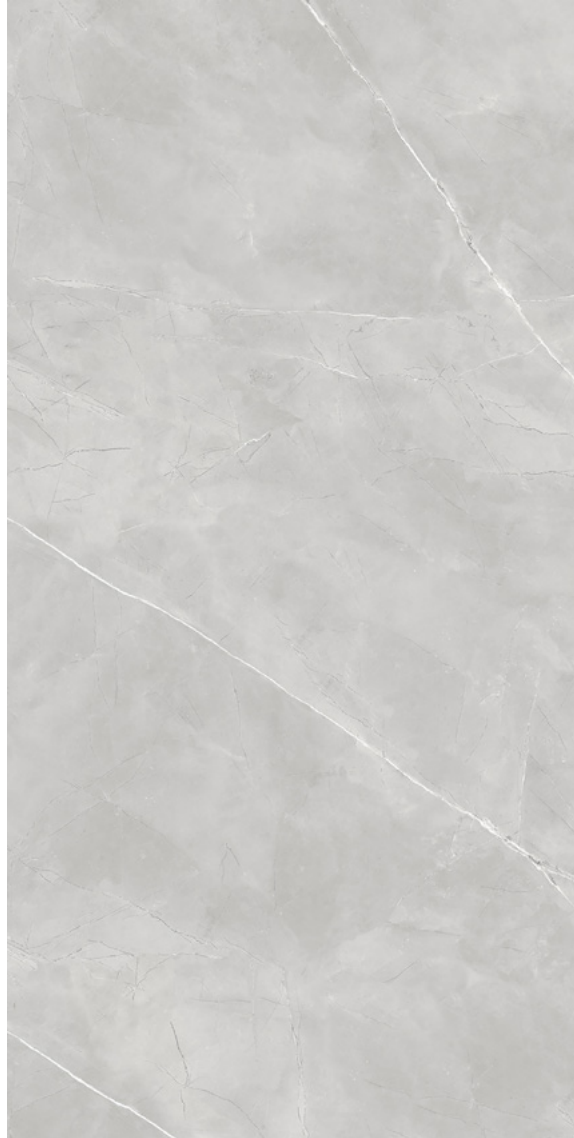

THICKNESS

6MM, 9 MM

SIZE

1200X2400MM

FINISH

GLOSSY

EFFECT

MARBLE

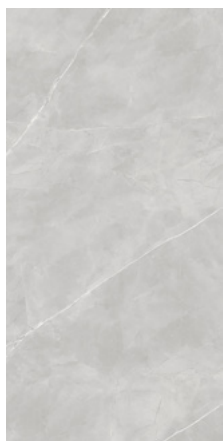
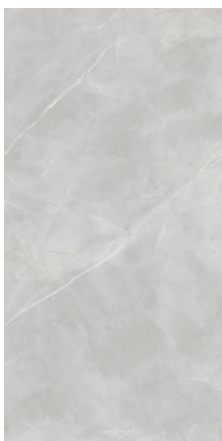
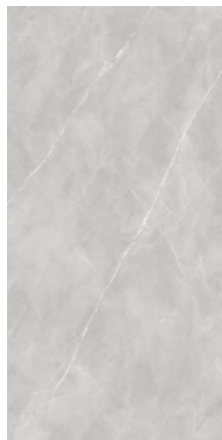
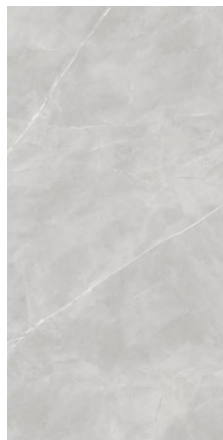
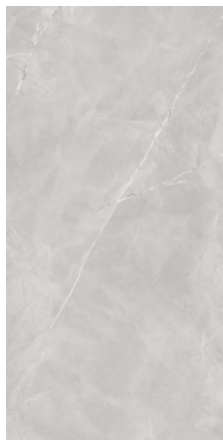
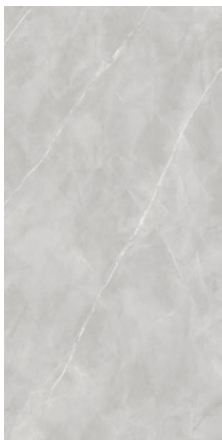

CALACATTA ELITE

RANDOM

8



THICKNESS

6MM, 9 MM

SIZE

1200X2400MM

FINISH

GLOSSY

EFFECT

MARBLE

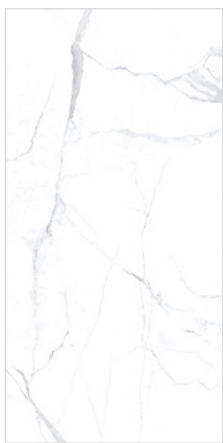
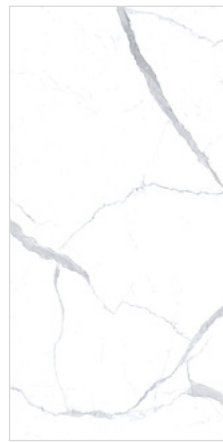

BLACK SYMPHONY

RANDOM

8

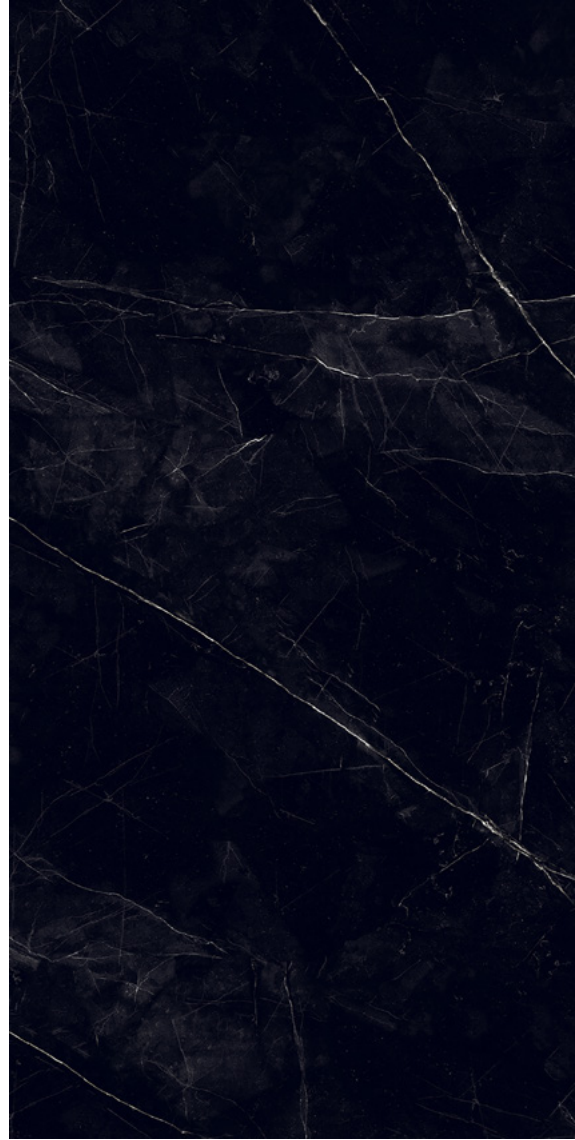
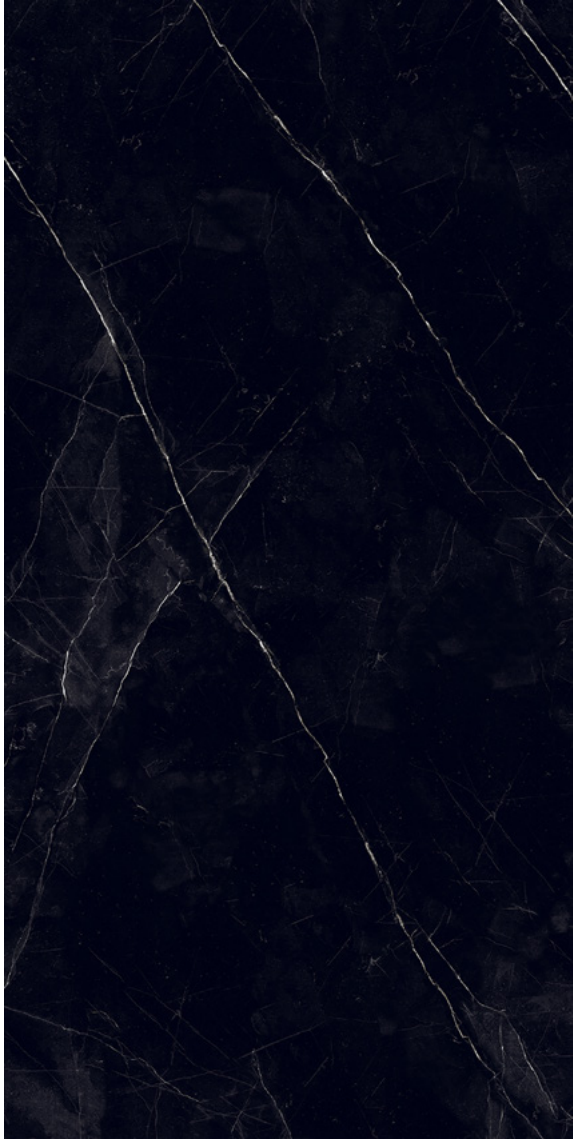

THICKNESS

6MM, 9 MM

SIZE

1200X2400MM

FINISH

GLOSSY

EFFECT

MARBLE

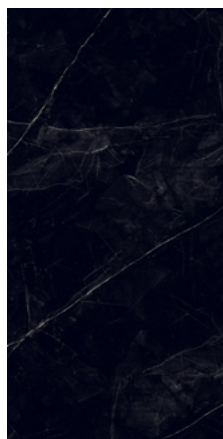
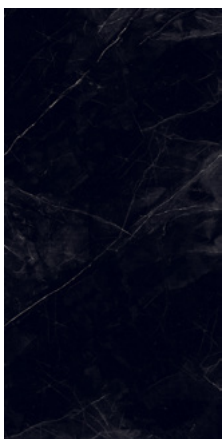
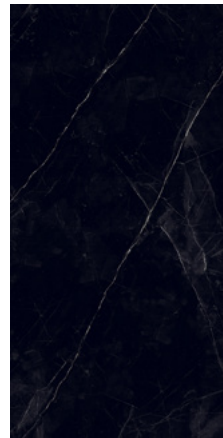
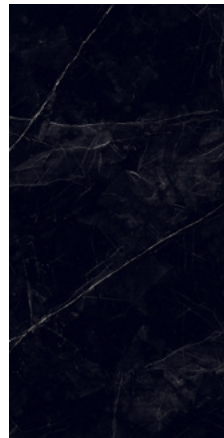
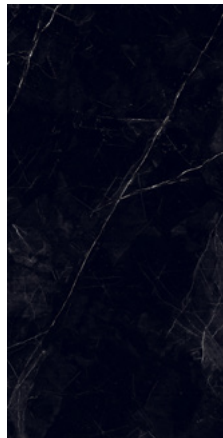
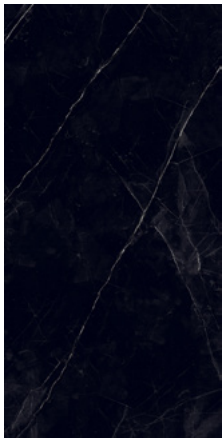

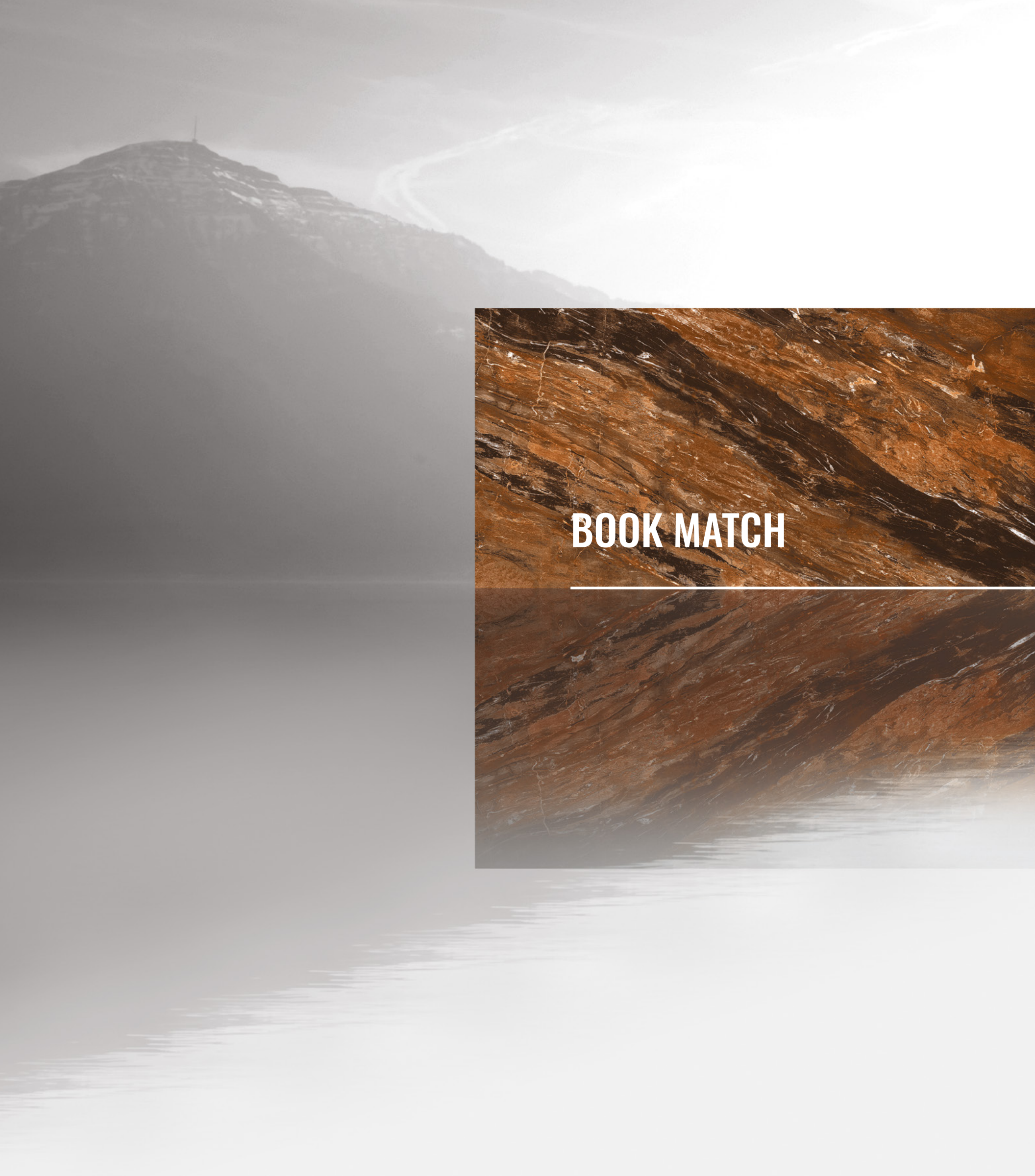

BOOK MATCH



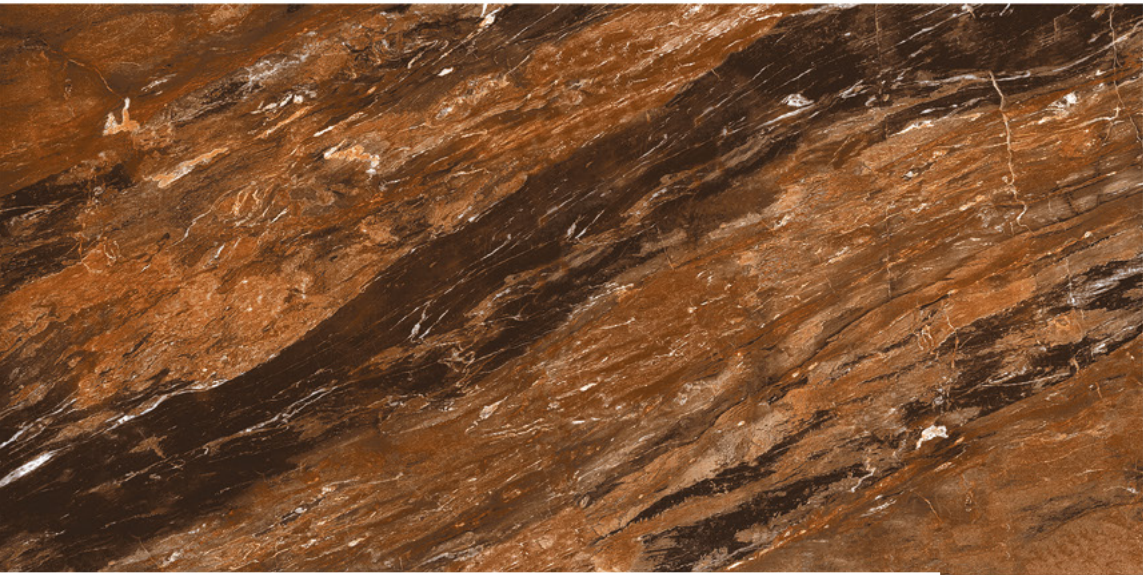



A



B

THICKNESS

6MM, 9 MM

SIZE

1200X2400MM

FINISH

GLOSSY

EFFECT

MARBLE

ARMANI GREY NEW BOOK MATCH

RANDOM

2

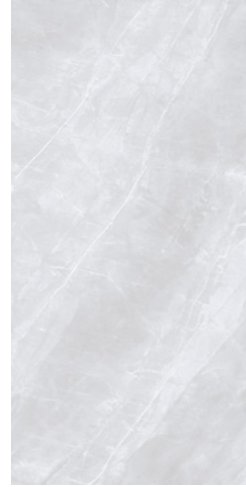

A

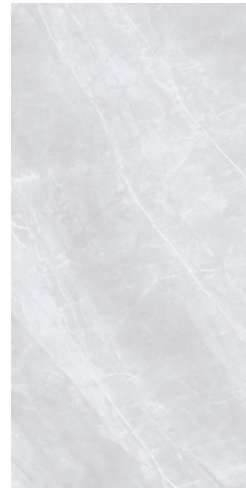

B

THICKNESS

6MM, 9 MM

SIZE

1200X2400MM

FINISH

GLOSSY

EFFECT

MARBLE



A



B

THICKNESS

6MM, 9 MM

SIZE

1200X2400MM

FINISH

GLOSSY

EFFECT

MARBLE

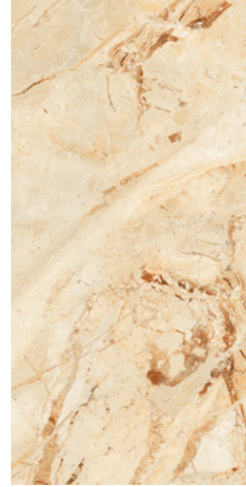

A

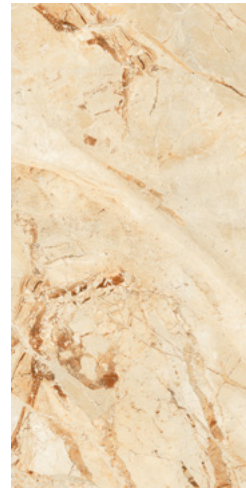

B

THICKNESS

6MM, 9 MM

SIZE

1200X2400MM

FINISH

GLOSSY

EFFECT

MARBLE



A



B

THICKNESS

6MM, 9MM

SIZE

1200X2400MM

FINISH

GLOSSY

EFFECT

MARBLE

CALCATA BORGHINI BOOK MATCH

RANDOM

2

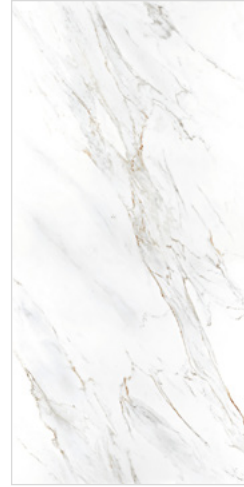

A

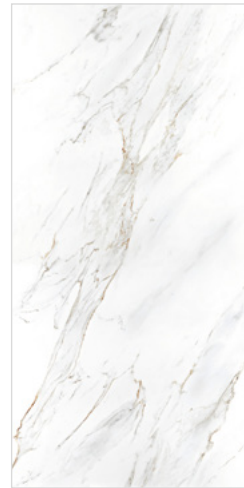

B

THICKNESS

6MM, 9 MM

SIZE

1200X2400MM

FINISH

GLOSSY

EFFECT

MARBLE

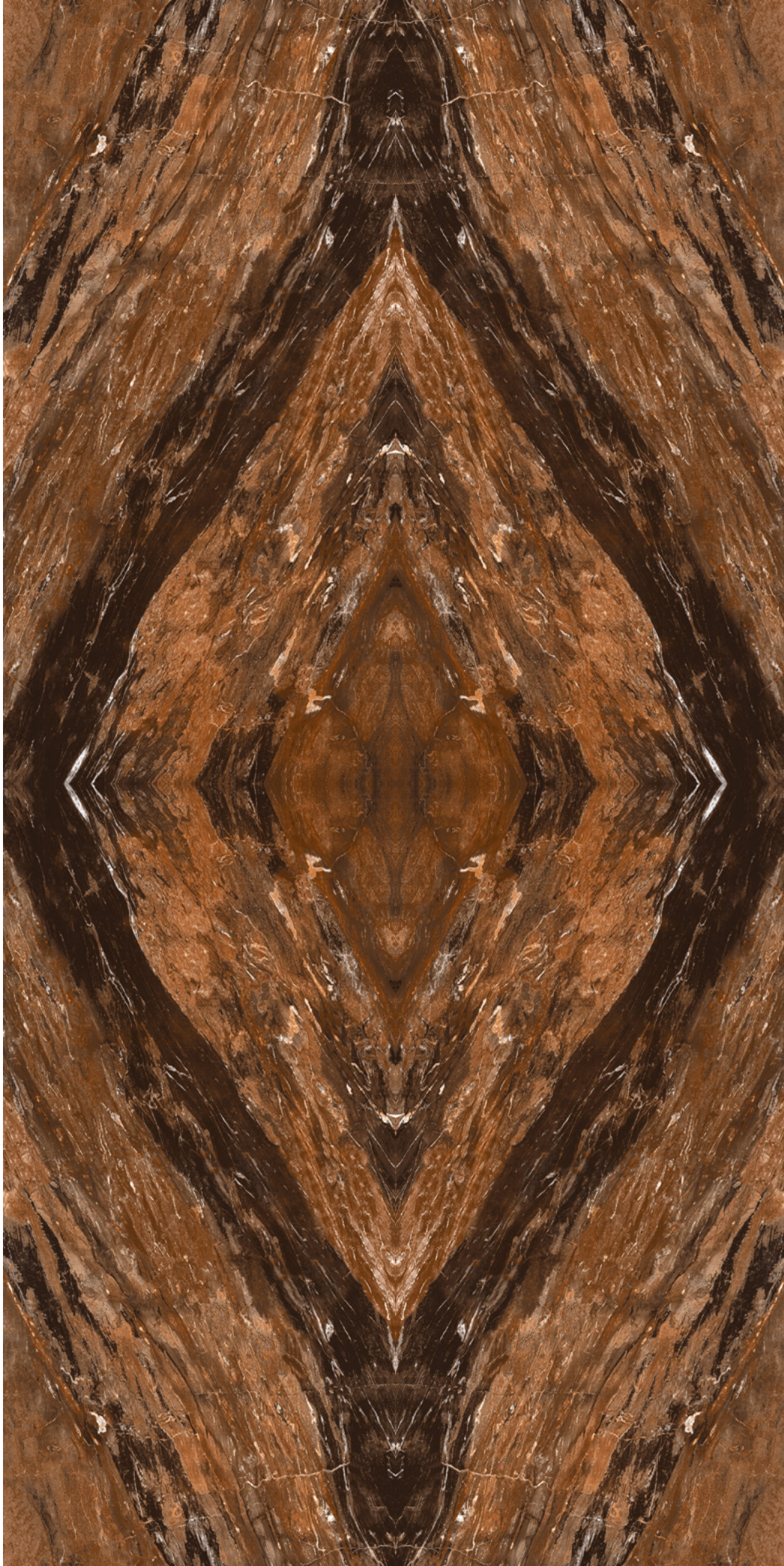

A

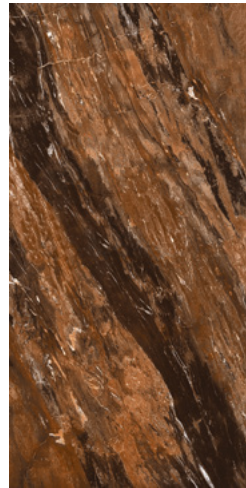

B

THICKNESS

6MM, 9 MM

SIZE

1200X2400MM

FINISH

GLOSSY

EFFECT

MARBLE

EXOTIC TAJ BOOK MATCH

RANDOM

2



A



B

THICKNESS

6MM, 9 MM

SIZE

1200X2400MM

FINISH

GLOSSY

EFFECT

MARBLE

SATUARIO PEARL BOOK MATCH

RANDOM

2

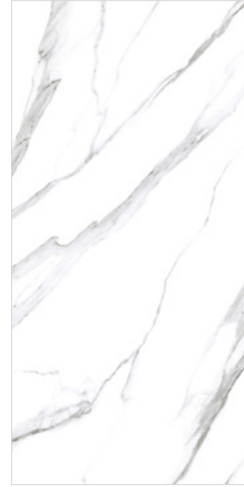
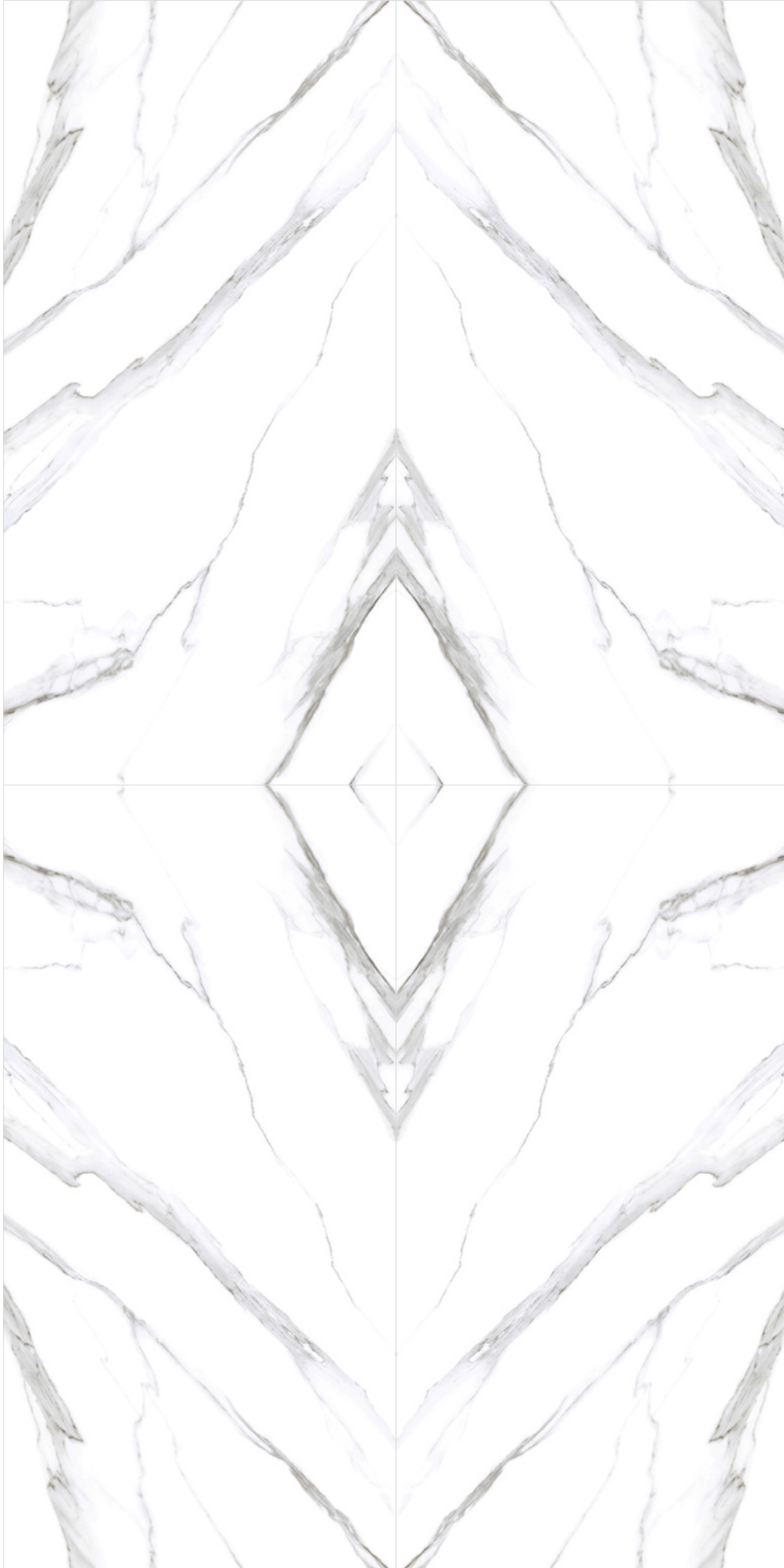

A

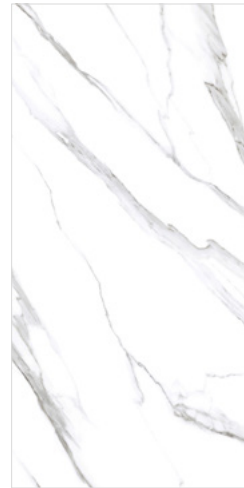

B

THICKNESS

6MM, 9 MM

SIZE

1200X2400MM

FINISH

GLOSSY

EFFECT

MARBLE

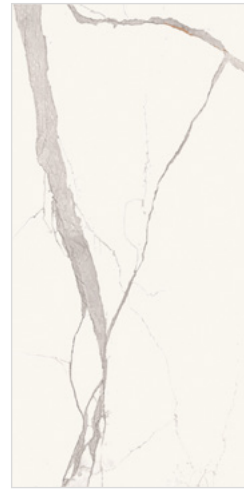

A

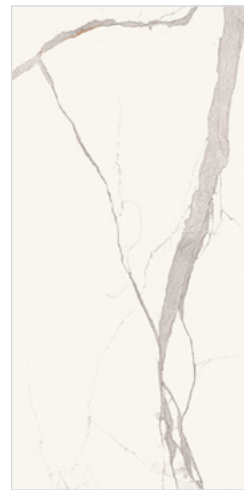

B

THICKNESS

6MM, 9 MM

SIZE

1200X2400MM

FINISH

GLOSSY

EFFECT

MARBLE

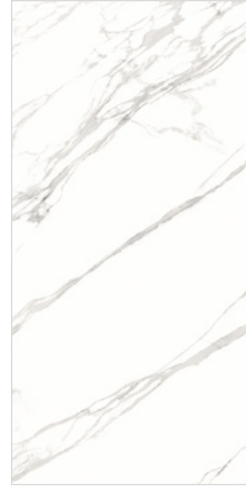

A

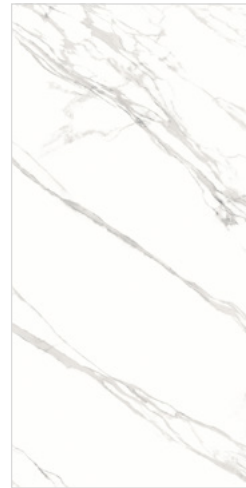

B

THICKNESS

6MM, 9 MM

SIZE

1200X2400MM

FINISH

GLOSSY

EFFECT

MARBLE

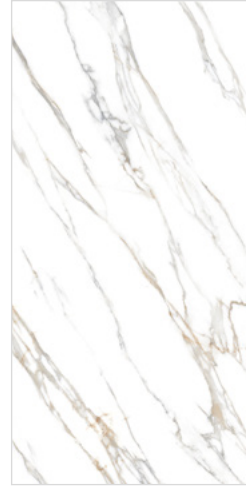

A

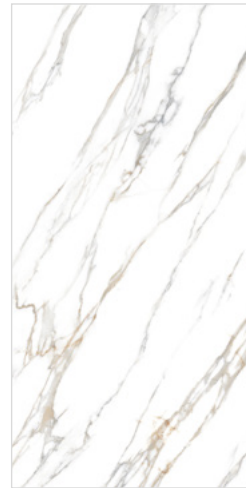

B

THICKNESS

6MM, 9 MM

SIZE

1200X2400MM

FINISH

GLOSSY

EFFECT

MARBLE

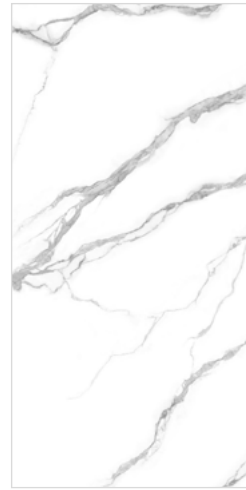
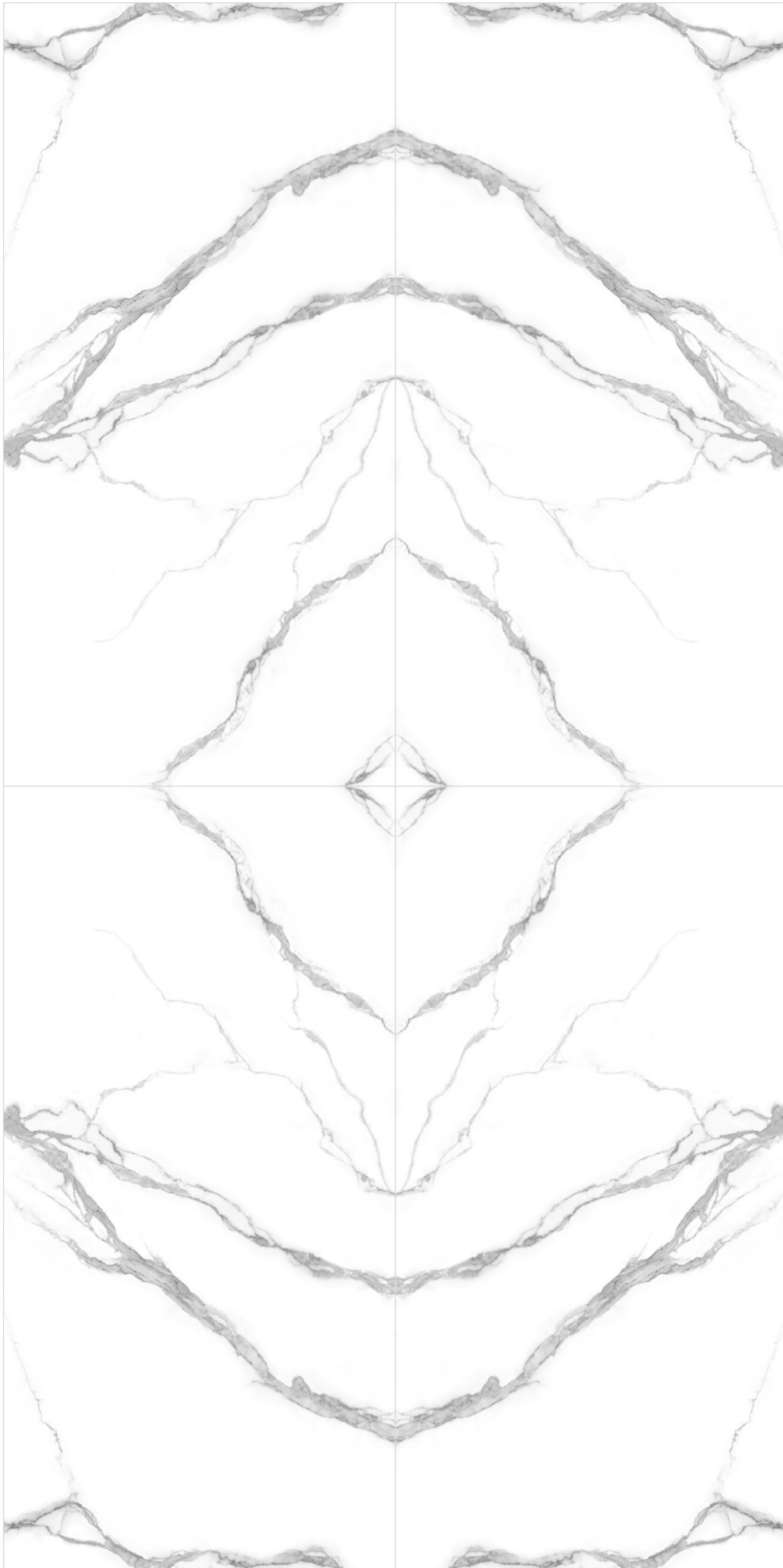

A

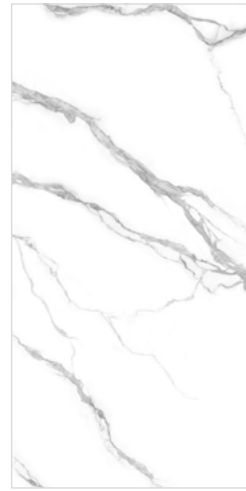

B

THICKNESS

6MM, 9MM

SIZE

1200X2400MM

FINISH

GLOSSY

EFFECT

MARBLE



FINISH



MATT

CARMEL BEIGE

RANDOM

2



CARMEL BIANCO

RANDOM

2



THICKNESS

6MM, 9 MM

SIZE

1200X2400MM

FINISH

MATT

EFFECT

MARBLE

CARMEL GREY

RANDOM

2



FOSSIL GREY

RANDOM

3

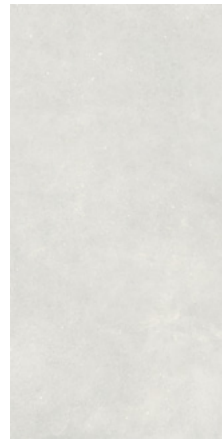

THICKNESS

6MM, 9 MM

SIZE

1200X2400MM

FINISH

MATT

EFFECT

MARBLE

FUSION WOOD GREYV

RANDOM

2



MEGA BROWN

RANDOM

2

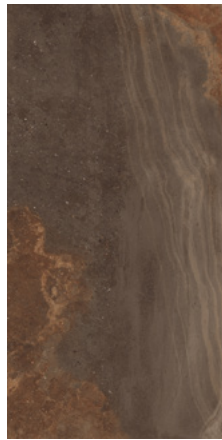

THICKNESS

6MM, 9 MM

SIZE

1200X2400MM

FINISH

MATT

EFFECT

MARBLE

MEGA CEMENTO

RANDOM

2



MEGA SAND

RANDOM

2



THICKNESS

6MM, 9 MM

SIZE

1200X2400MM

FINISH

MATT

EFFECT

MARBLE

NOIR DESIR

RANDOM

OXIDE EARTH

RANDOM

4

3

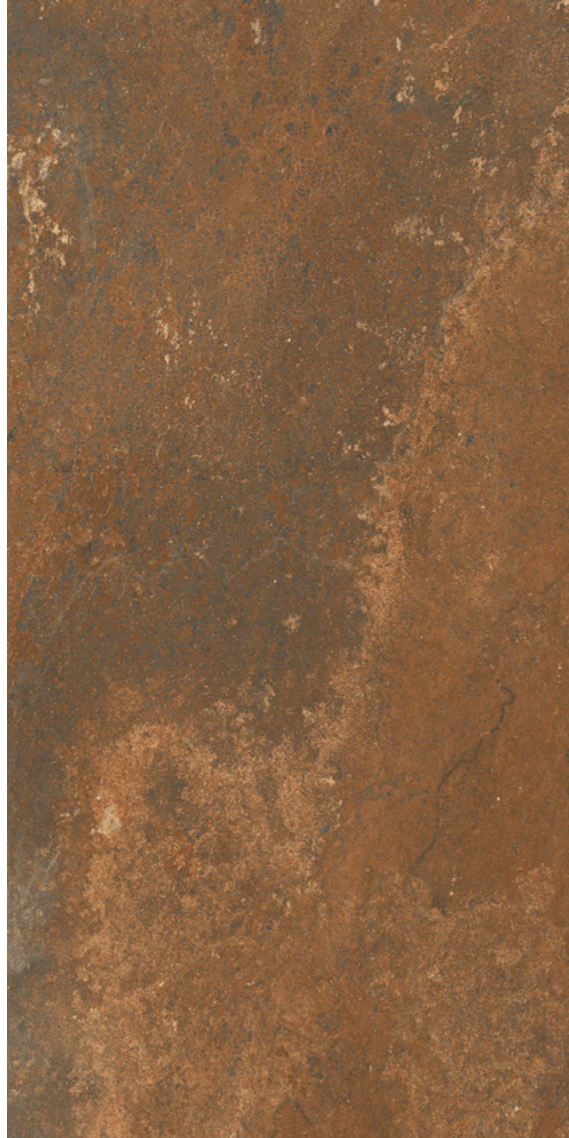

THICKNESS

6MM, 9 MM

SIZE

1200X2400MM

FINISH

MATT

EFFECT

MARBLE

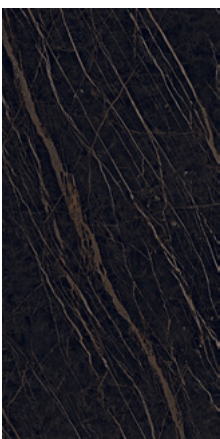
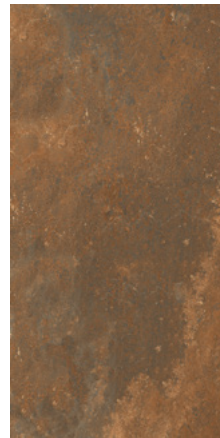
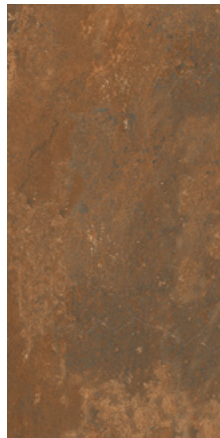
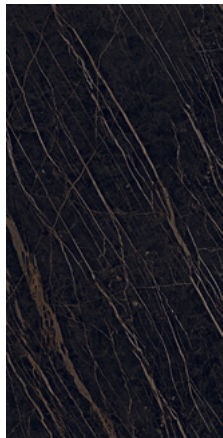
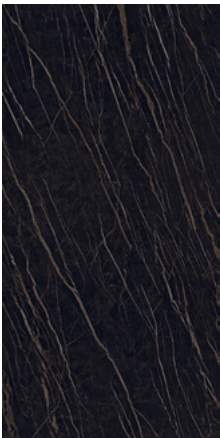

—
QUITE MIST

RANDOM
—

2

—
QUITE ANTHRACITE

RANDOM
—

2



THICKNESS
—

6MM, 9 MM

SIZE
—

1200X2400MM

FINISH
—

MATT

EFFECT
—

MARBLE

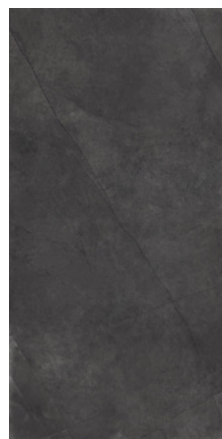

QUITE ASH

RANDOM

QUITE BROWN

RANDOM

2

2

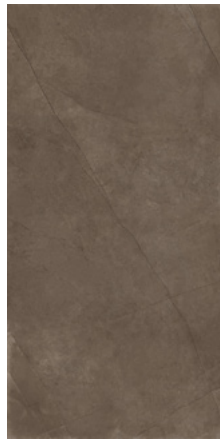

THICKNESS

6MM, 9 MM

SIZE

1200X2400MM

FINISH

MATT

EFFECT

MARBLE

TREDI BIANCO

RANDOM

1

TREDI BROWN

RANDOM

1

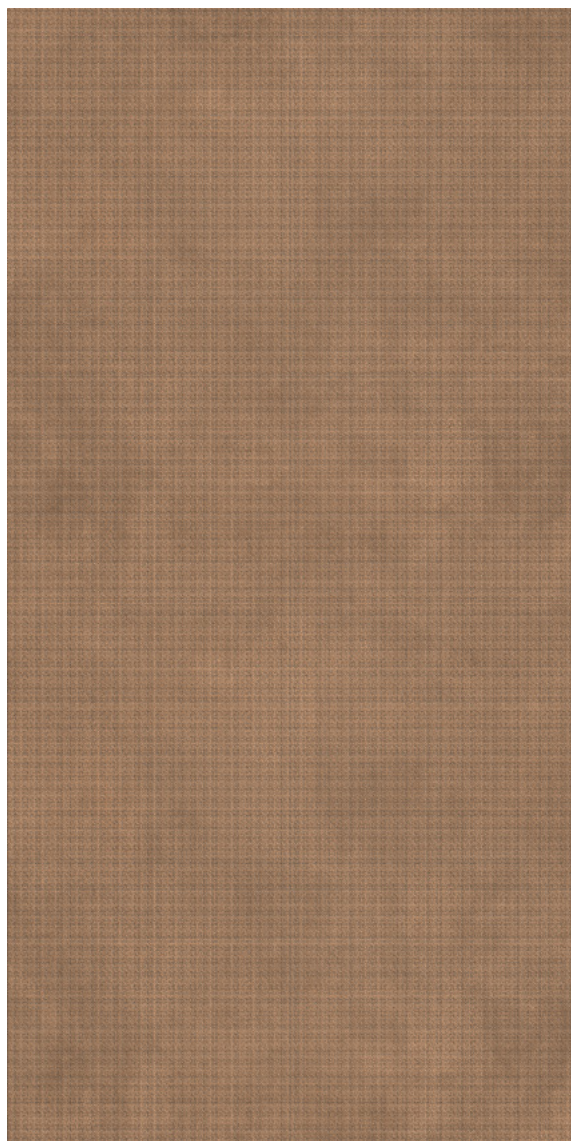
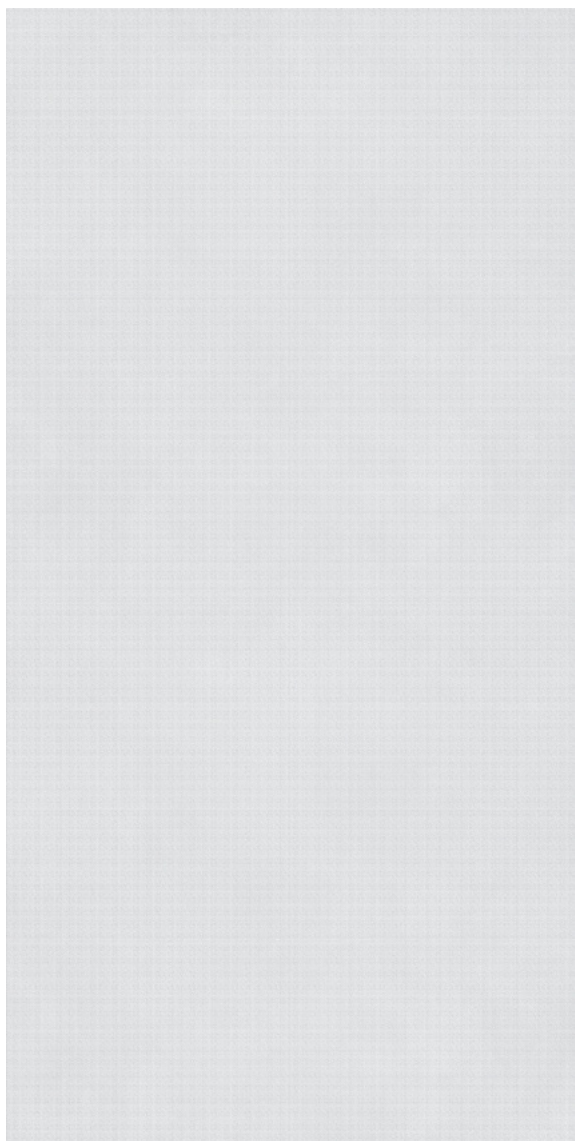

THICKNESS

6MM, 9 MM

SIZE

1200X2400MM

FINISH

MATT

EFFECT

MARBLE

TREDI GREY

RANDOM

URBAN GREY

RANDOM

1

3

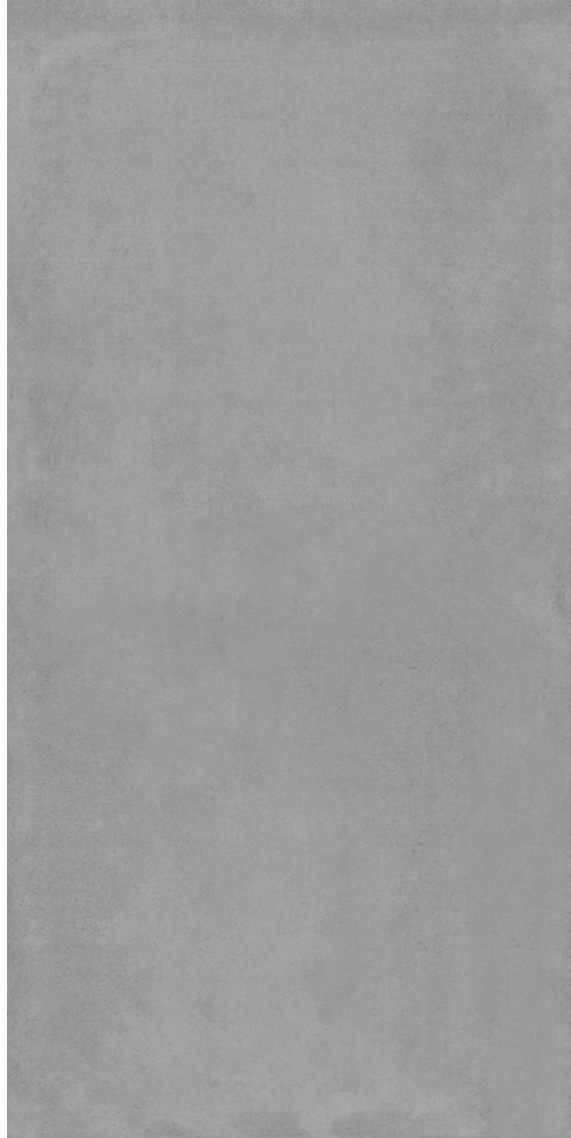
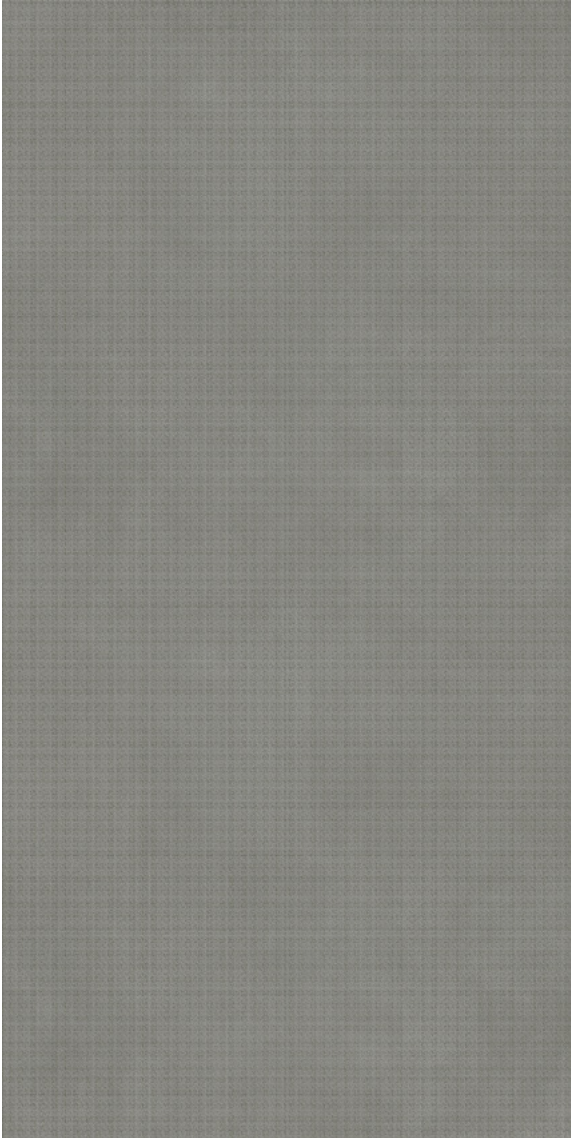

THICKNESS

6MM, 9 MM

SIZE

1200X2400MM

FINISH

MATT

EFFECT

MARBLE

TECHNICAL SPECIFICATION

CHARACTERISTICS	STANDARD AS PER ISO-13006/En14411 GROUP	VALUES	TEST METHOD
-----------------	--	--------	-------------

REGULATORY PROPERTIES

Deviation in Lenth & Width	0.50%	0.20%	ISO - 10545-2
Deviation in Thickness	0.50%	0.50%	ISO - 10545-2
Straightness of Sides	0.50%	0.20%	ISO - 10545-2
Rectangularity	0.50%	0.20%	ISO - 10545-2
Surface Flatness	0.50%	0.20%	ISO - 10545-2
Color Difference	Unaltered	No Change	ISO - 10545-16
Glossiness	As per Mfg.	>90%	Glossmeter

STRUCTURAL PROPERTIES

Water Absorption	<0.05%	<0.05%	ISO - 10545-3
Apparent Density	>2.00 g/cc	>2.10 g/cc	DIN 51082

MASSIVE MECHANICAL PROPERTIES

Modulus of Repture	Min 35N/MM2	Min 40N/MM2	ISO - 10545-4
Breaking Strength	Min. 1300 N	Min. 2000 N	ISO - 10545-4
Impact Resistance	As per Mfg.	Min. 0.55	ISO - 10545-5

SURFACE MECHANICAL PROPERTIES

Surface Abrasion Resistance	As per Mfg.	Min. class 3	ISO - 10545-7
Moh's Hardness	As per Mfg.	Min. class 4	EN 101

THERMO HYGROMETRIC PROPERTIES

Frost Resistance	No Damage	No Damage	ISO - 10545-12
Thermal Shock Resistance	No Damage	No Damage	ISO - 10545-09
Moisture Expansion	Nil	Nil	ISO - 10545-10
Thermal Expansion	Max 9.0x10 ⁻⁶	Max 6.5x10 ⁻⁶	ISO - 10545-08
Crazing Resistance	As per Mfg.	Min 10 Cycle	ISO - 10545-11

CHEMICAL PROPERTIES

Chemical Resistance	No Damage	No Damage	ISO - 10545-13
Stain Resistance	Resistant	Resistant	ISO - 10545-14

SAFETY PROPERTIES

Slip Resistance	As per Mfg.	>0.40	ISO - 10545-17
Fire Resistance	As per Mfg.	Fire Proof	N.A.

PACKING DETAIL

SIZE (in mm)	THICKNESS APPROX	PIECES / PER BOX	COVERAGE AREA IN SQ. FT	BOX WEIGHT (APPROX.)
1200x2400 MM	6 MM	1	31	42
1200x2400 MM	9 MM	1	31	61

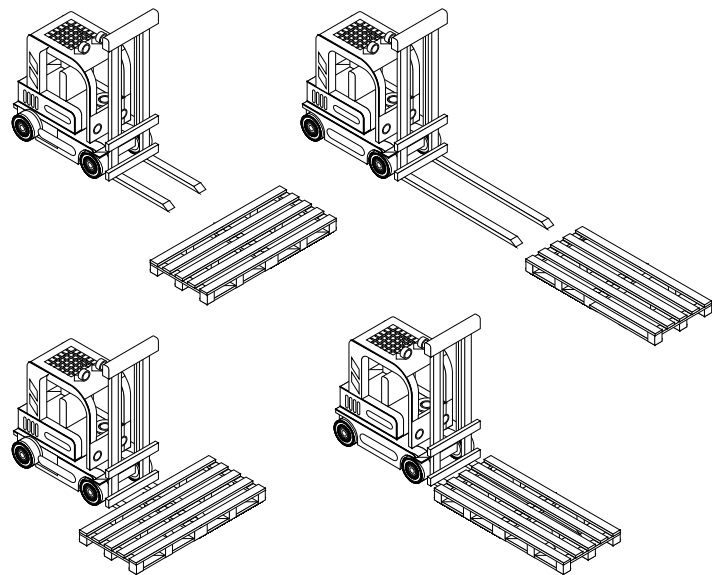

✓ RIGHT

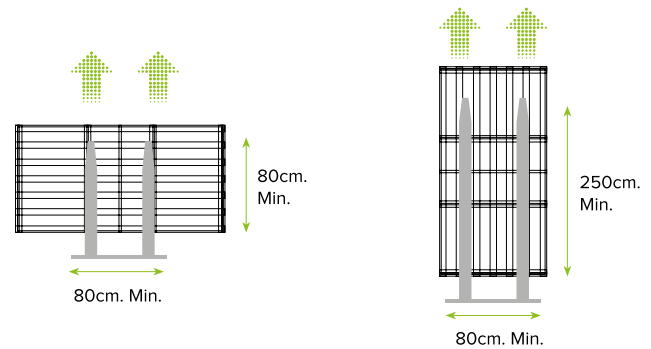
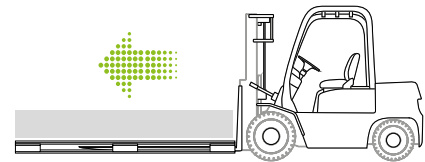

✗ WRONG

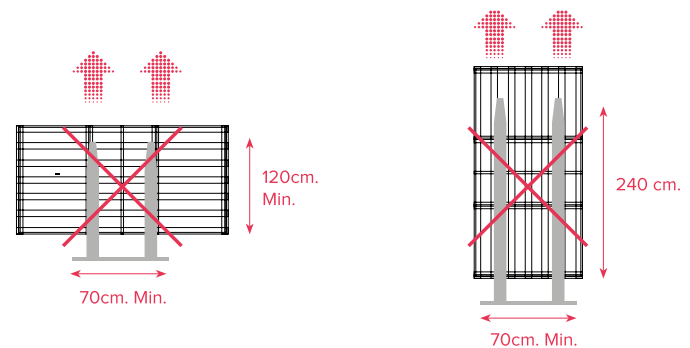
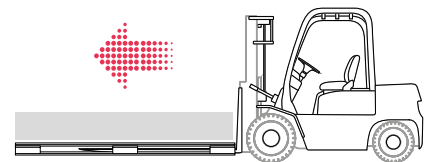

STORAGE

We should use a forklift truck, at least 2,5 mts. long, with the forks positioned in the largest width position, in order to handle the pallet on a proper way. Under normal conditions, the forks are positioned in the middle of the long side of the pallet, as they must hold the whole depth of the pallet. To allow the extraction of the slabs in a safe and easy way, it is recommended to position the pallets in a suitable area where the lift truck can be moved around all sides of the pallet.

HANDLING SLAB

Fab Slab's extra-large format slabs arrived in oversized crates, which require specific handling equipment. To prevent damage from occurring during forklift operation, specific fork sizes must be used. For example, to handle a crate of 135cm x 305cm tiles from the side, 112cm/44" long forks are recommended.

To handle the same crate from the narrow end requires forks that are at least 213cm/84" long. Lifting multiple crates with longer forks may require forklifts with a greater lift capacity.

Specialized tools and equipment are currently available for the handling and installation of large porcelain surfaces. Innovative trowels with unique notch configurations can help increase the consistency of the mortar coverage on the back of the tile.

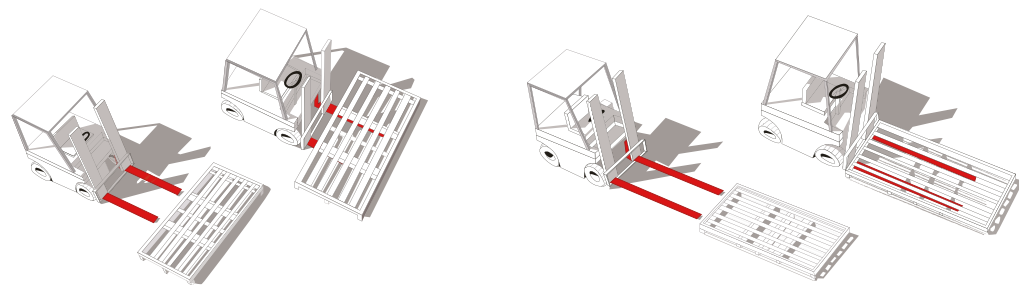

HANDLING EQUIPMENT

Handling device to free move 150X150 Slabs (use 2 for 305cm Slab)



Double Suction Cup 115 MM



Modular Bench BM 180



LEVELLING EQUIPMENT

RLS Clips for Tiles 10-12 MM thick (½" - ¾") - 400 pcs bag

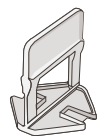

Wedges in 1000 pcs / carton

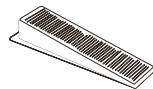

Adjustable pliers for wall and floor covering



CUTTING EQUIPMENT

Free cut guide with complete outfit Max. cut of length-156 CM



Free cut extension length - 170 CM



Cutting of pillars for tiles/slabs Thickness 6-12 MM

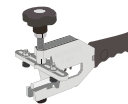

MECHANICAL FIXING EQUIPMENT

Fix Stainless Steel Hook for 8 MM thickness tiles - 500 pcs

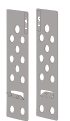

Cut Grooving Machine 850w-230v 50/60hz

